



Manufacturers, & Exporters of Dental, Surgical, Orthodontic, Hollow Wears & Manicure Instruments.

Dental Instruments Catalogue

Dear Valued Buyers

We feel immense pleasure to present our latest catalogue in which we have featured a most comprehensive range of all types of quality Surgical & Dental instruments required for day to day use for Hospital. We will be pleased to quote you a competitive Price and Delivery time.

All instruments are manufactured according to the recognized standard patterns currently in use in Hospital throughout the world and are being produced under restrict control of experts to avoid any flaw and to refrain any complaint at any stage.

A group of very vast experienced persons in manufacturing handling our quality Control System.

Any instruments proven defective in workmanship or material will be replaced with out charges.

We express our thanks to all our customers for the confidence they have placed us in the past. We further assure them that we will continue our best efforts to gain their confidence in the future.

We are always at your service.

Chief Executive
MEDSTR INTERNATIONAL

01**EXTRACTING FORCEPS****Page # 01 - 28****02****ROOT ELEVATORS****Page # 29 - 48****03****DIAGNOSTIC, PROBES, SCALERS, FILLING
& LABORATORY INSTRUMENTS****Page # 49 - 98****04****MAXILLOFACIAL SURGERY
INSTRUMENTS****Page # 99 - 124****05****ORTHODONTIC INSTRUMENTS
& PLIERS****Page # 125 - 144****06****DENTAL IMPLANT INSTRUMENTS
& Impression Tray****Page # 145 - 182****07****HOLLOWARE****Page # 183 - 191**

Handle Selection For Extracting Forceps

Dear Valued Buyers if any Universal Fig. No. of Extracting Forceps not Found in our Catalogue you Can Refer the Fig. No. From These Diagram.

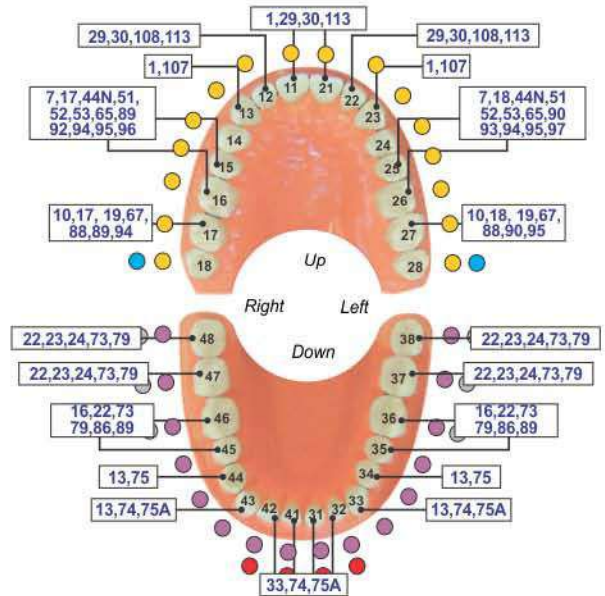
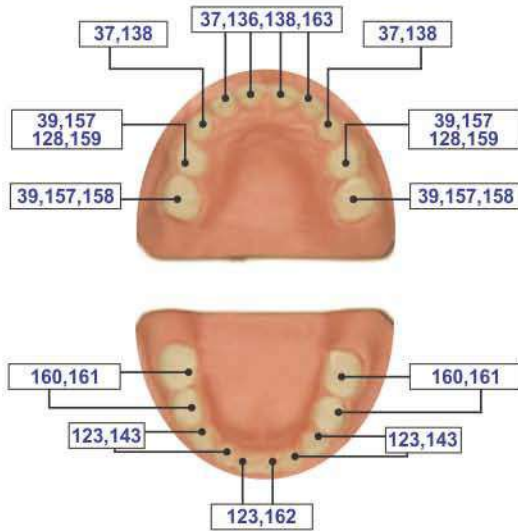

Dear Valued Buyers these are our Handle Styles



EXTRACTING FORCEPS (English Pattern)

- Щипцы экстракционные (английская форма)
- Daviers (Forme Anglaise)
- Zahnzangen (Englische Form)
- Щипці екстракційні (англійська форма)
- Forceps de Extracción (Forme Inglesa)
- استخراج المنقط (تمط اللغة الإنجليزية)

Function: To remove teeth from bony socket



MD-001

Fig. 1
Upper Centrals
and Canines



MD-002
Fig. 2
Upper Laterals
and Canines



MD-003
Fig. 4
Lower Incisors
and Canines



MD-004
Fig. 7
Upper Premolars



MD-005
Fig. 8
Lower Premolars



MD-006
Fig. 13
Lower Premolars



MD-007
Fig. 17
Upper Molars,
Right



MD-008
Fig. 18
Upper Molars, Left



MD-009
Fig. 21
Lower Molar



MD-010
Fig. 22
Lower Molar



Straight extracting forceps for upper incisors and canines



Straight extracting forceps for upper incisors and canines



Straight extracting forceps for upper incisors and canines

EXTRACTING FORCEPS (English Pattern)



- Щипцы экстракционные (английская форма)
- Щипці екстракційні (англійська форма)
- Daviers (Forme Anglaise)
- Forceps de Extracción (Forme Inglesa)
- Zahnzangen (Englische Form)
- استخراج الملقط (نمط اللغة الإنجليزية)

Function: To remove teeth from bony socket



MD-011
18A
upper molars



MD-012
19
upper third molars



MD-013
20
lower third molar



MD-014
24
lower molar, right



MD-015
29
upper roots



MD-016
30
Upper Roots



MD-017
33
lower roots



MD-018
33A
Lower Roots



MD-019
33M
Lower roots
with long beak



MD-020
46L



MD-021
51
Upper Roots



MD-022
51A
Upper Roots



Straight extracting forceps for upper incisors and canines



Straight extracting forceps for upper incisors and canines



Straight extracting forceps for upper incisors and canines

EXTRACTING FORCEPS (English Pattern)

- Щипцы экстракционные (английская форма)
- Щипці екстракційні (англійська форма)
- Daviers (Forme Anglaise)
- Forceps de Extracción (Forme Inglesa)
- Zahnzangen (Englische Form)
- استخراج الملقط (تمط اللغة الإنجليزية)

Function: To remove teeth from bony socket

WISDOM EXTRACTING FORCEPS



MD-023
Routerier
(# 22 1/2 L)
lower molars and
wisdoms, left



MD-024
Routerier
(# 22 1/2 R)
lower molars and
wisdoms, right



MD-025
Routerier
(# 33 1/2 L)
lower molar and
wisdom roots, left



MD-026
Routerier
(# 33 1/2 R)
lower molar and
wisdom roots, right



Routerier extracting forceps for lower molars and third molars, right



MD-027
Fig. 186L
lower molars



MD-028
Fig. 186R
lower molars



MD-029
51AL



MD-030
67
Upper Third Molars



MD-031
67A
Upper Third Molars



MD-032
79
Lower Third Molars



Angled extracting forceps for upper roots

EXTRACTING FORCEPS (English Pattern)



- Щипцы экстракционные (английская форма)
- Щипці екстракційні (англійська форма)
- Forceps de Extracción (Forme Inglesa)
- Zahnzangen (Englische Form)
- استخراج الملقط (نمط اللغة الإنجليزية)



MD-033
73
Lower Molars



MD-034
73 A
lower molars



MD-035
73 S



MD-036
74
Lower Roots



MD-037
74N
Lower Roots



MD-038
75
Lower Premolars



MD-039
86A
Lower Molars



MD-040
86B
lower molars



MD-041
86C
lower molars



MD-042
87
Lower Molars



MD-043
89
Upper Molars,
Right



MD-044
90
Upper Molars,
Left



Straight extracting forceps for upper incisors and canines



Straight extracting forceps for upper incisors and canines



Straight extracting forceps for upper incisors and canines

EXTRACTING FORCEPS (English Pattern)

- Щипцы экстракционные (английская форма)
- Daviers (Forme Anglaise)
- Zahnzangen (Englische Form)
- Щипці екстракційні (англійська форма)
- Forceps de Extracción (Forme Inglesa)
- استخراج المنقط (تمط اللغة الإنجليزية)

DE-TRAUMATIC EXTRACTION

Improved tapered beaks for complete root contact. Cross serrations. Deep Gripe Extracting Forceps



- No Fracture
- No Tissue Damage
- Extraction With Easy



Thin Tip

MD-045
34

Upper incisors and premolars deep-gripping



Wide Tip

MD-046
34A

Upper centrals / cains deep-gripping



Thin Tip

MD-047
Fig. 35

upper permolars deep-gripping



Wide Tip

MD-048
35A

Upper incisors and premolars deep-gripping

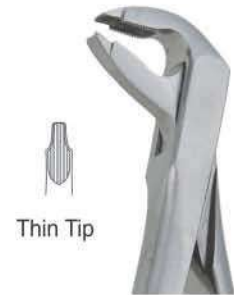

Thin Tip

MD-049
36

Lower premolars deep-gripping



Wide Tip

MD-050
36A

Lower premolars deep-gripping



MD-051
336

lower permolars deep-gripping



MD-052
F-7C

lower molar



MD-053
9

Apex Forceps Lower Universal Deep Root Pick



MD-054
79N

Lower third molars deep-gripping



MD-055
79

Lower Thrid Molars



Function:

Extraction forceps are used to further loosen teeth by rotational and tilting movements and finally to extract the teeth in combination with a fulcrum.

EXTRACTING FORCEPS (English Pattern)



- Щипцы экстракционные (английская форма)
- Щипці екстракційні (англійська форма)
- Daviers (Forme Anglaise)
- Forceps de Extracción (Forme Inglesa)
- Zahnzangen (Englische Form)
- استخراج الملقط (نمط اللغة الإنجليزية)

DEEP ROOT PICK FORCEPS



MD-056
146

Apex Forceps Lower Root
Deep Root Pick



MD-057
153

Apex Forceps Upper Root
Deep Root Pick



MD-058
149

Apex Forceps Upper Root
Deep Root Pick



MD-059
Fig. 44



MD-060
Fig. 44Z



MD-061
Fig. 45Z



MD-062
46XL
Apex Forceps Lower Root
Deep Root Pick



MD-063
67
Upper Third Molars

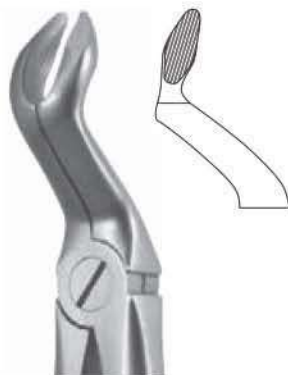

MD-064
67A
Upper Third Molars



MD-065
67N
Lower third molars
deep-gripping



MD-066
331
upper roots
deep-gripping



forceps for upper incisors, premolars and roots



EXTRACTING FORCEPS (English Pattern)

- Щипцы экстракционные (английская форма)
- Daviers (Forme Anglaise)
- Zahnzangen (Englische Form)
- Щипці екстракційні (англійська форма)
- Forceps de Extracción (Forme Inglesa)
- استخراج المنقط (تمط اللغة الإنجليزية)



Fig. 1
upper
laterals
and canines



MD-067
Set of 10 Pieces
Fig. 1
Fig. 7
Fig. 13
Fig. 17
Fig. 18
Fig. 22
Fig. 51A
Fig. 67
Fig. 74N
Fig. 79

Fig. 7
upper premolars



Fig. 13
lower premolars



Fig. 17
upper molars, right



Fig. 18
upper molars, left



Fig. 22
lower roots



Fig. 51A
upper roots



Fig. 67
upper third molars



Fig. 74N
lower molar



Fig. 79
lower third molars



Extracting forceps for upper roots



EXTRACTING FORCEPS



- Щипцы экстракционные
- Щипці екстракційні
- Daviers
- Forceps de Extracción
- Zahnzangen
- استخراج المنقط

Pediatric Tooth Extracting Forceps Set



MD-069
English Pattern Klein #51S
Pedodontic Upper root.



MD-068
English Pattern Klein #137
Pedodontic, Upper Incisors Spring handle



MD-072
English Pattern Klein #5
Pedodontic Lower Incisors.



MD-070
English Pattern Klein #139
Pedodontic Upper Premolars

Baby Tooth Extraction Forceps



MD-075
Fig. # 01 to 07
Set of 7 Pieces



MD-073
English Pattern Klein #7
Pedodontic Lower Roots,



MD-071
English Pattern Klein #3
Pedodontic Upper Molars Universal

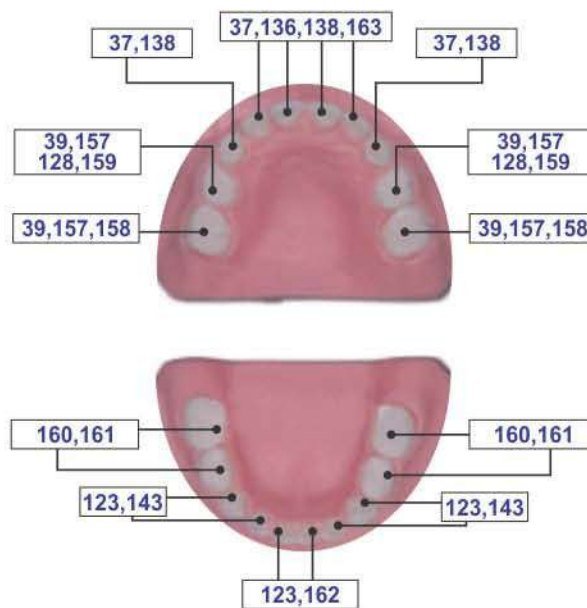

MD-074
English Pattern Klein #6
Pedodontic Lower Molars, Spring Handle



Witzel
MD-076
170mm
Upper roots, Universal



Witzel
MD-077
165mm
Lower roots, Universal

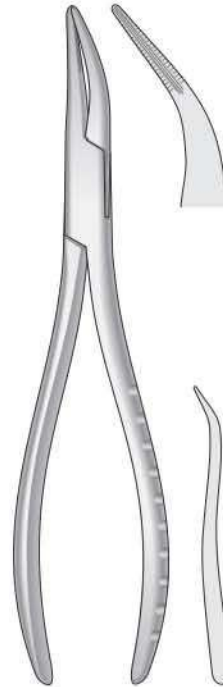

MD-078
#400(300)
165mm
Upper roots, Universal

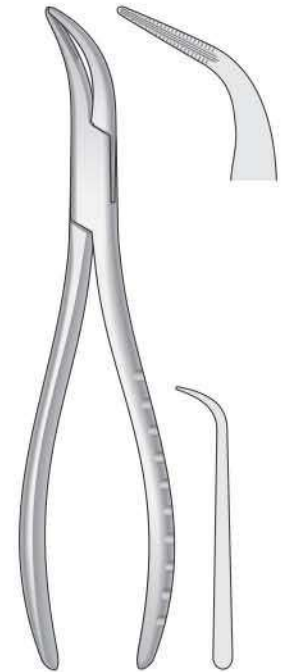

MD-079
#401(301)
160mm
Lower roots, Universal



MD-080
Witzel Forceps With Gold
Set of 3 Pcs



MD-084
Witzel Forceps With Hole And Screw Pattern
Set of 3 Pcs



MD-088
Witzel Forceps With Anatomical Handle
Set of 3 Pcs



MD-081
#401(301)
160mm
Lower roots, Universal



MD-085
#401(301)
160mm
Lower roots, Universal



MD-089
#401(301)
160mm
Lower roots, Universal



MD-082
#400(300)
165mm
Upper roots, Universal



MD-086
#400(300)
165mm
Upper roots, Universal



MD-090
#400(300)
165mm
Upper roots, Universal



Witzel
MD-083
165mm
Lower roots, Universal



Witzel
MD-087
165mm
Lower roots, Universal



Witzel
MD-091
165mm
Lower roots, Universal

ROOTS SPLINTER FORCEPS



- Щипцы для удаления корневых осколков
- Pincers Fragments
- Wurzelsplitterzangen
- Щипці для видалення корневих осколків
- Pinzas Para Fragmentos
- جزور منشقة الملقط



MD-092
Splinter Forceps
15.5cm

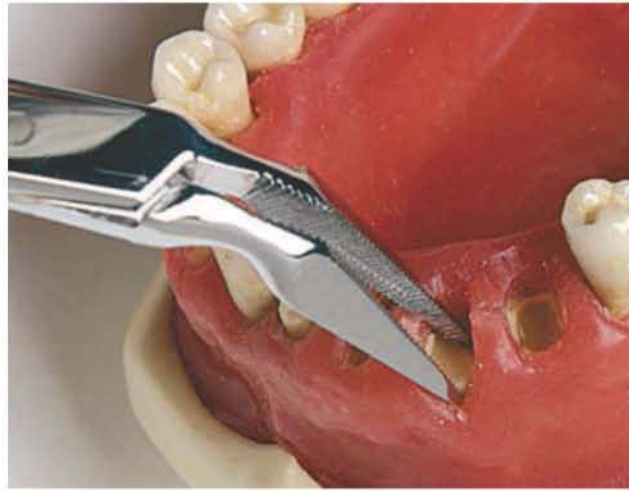

Stieglitz Root Splinter Forceps



MD-093
Splinter Forceps
15.5cm 45°

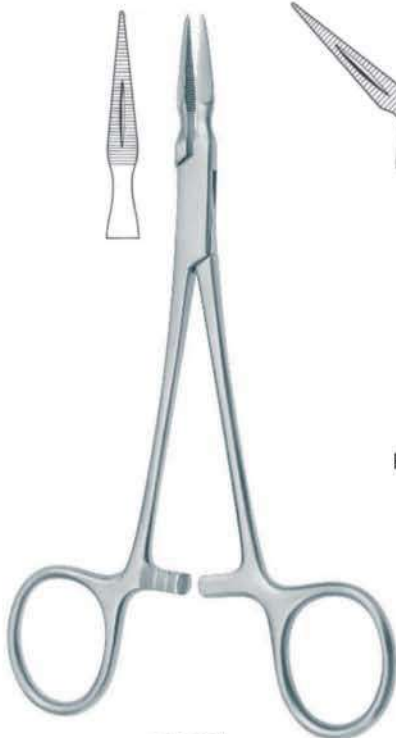

MD-094
Stieglitz
Root Fragments



MD-095
Stieglitz
Root Fragments



MD-096
Stieglitz Splinter Forceps
140mm 90°



MD-097
Stieglitz Splinter Forceps
140mm Straight

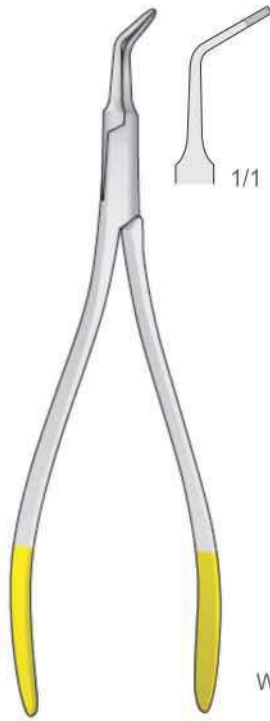

With Diamond

MD-098
130mm

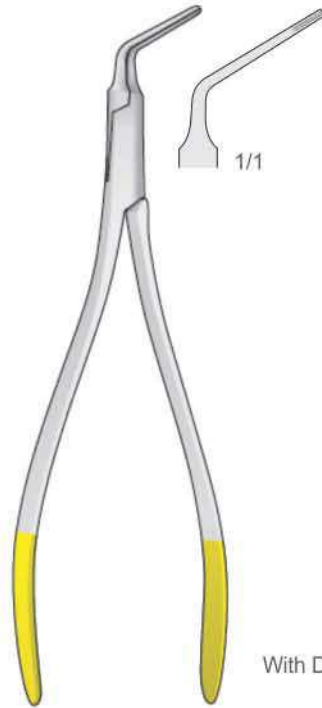

With Diamond

MD-099
130mm

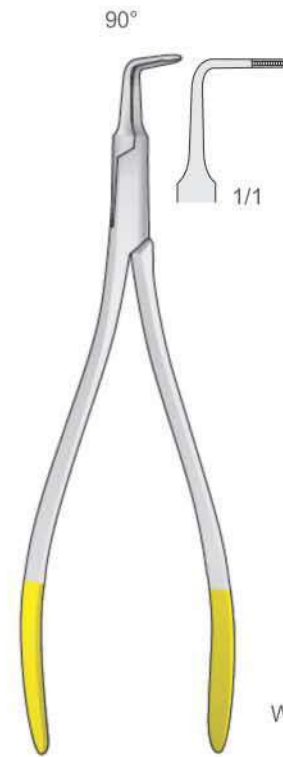

With Diamond

MD-100
125mm



MD-101
130mm

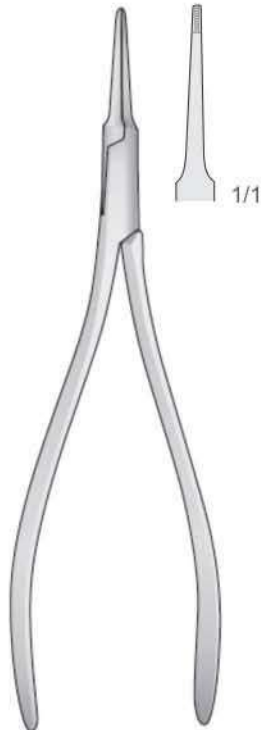

MD-102
130mm



MD-103
125mm

EXTRACTING FORCEPS (American Pattern)



- Щипцы экстракционные (американская форма)
- Daviers - forme américaine
- Fórceps de extracción - forma americana
- Щипці екстракційні (американська форма)
- Pinzere per estrazione - forma americana
- استخراج الملقط (النمط الأمريكي)



MD-104
1STD
Winter
upper centrals and canines

MD-105
Fig. 1
upper incisors
and roots

MD-106
Cryer
Fig. 150

EXTRACTING FORCEPS (American Pattern)

- Щипцы экстракционные (американская форма)
- Щипці екстракційні (американська форма)
- Daviers - forme américaine
- Pinzeper per estrazione - forma americana
- Fórceps de extracción - forma americana
- استخراج الملقط (النمط الأمريكي)



MD-107
Fig. 150A
Cryer
upper incisors, premolars, roots



MD-108
Fig. 62
incisors, premolars,
deciduous teeth



MD-109
10S
upper roots



MD-110
17
lower molars



MD-111
Harris
Fig. 18R



MD-112
Harris
Fig. 18L

EXTRACTING FORCEPS (American Pattern)



- Щипцы экстракционные (американская форма)
- Daviers - forme américaine
- Fórceps de extracción - forma americana
- Щипці екстракційні (американська форма)
- Pinzere per estrazione - forma americana
- استخراج الملقط (النمط الأمريكي)



MD-113
Fig. 210
upper third molars



MD-114
Fig. 53R
upper molars, right



MD-115
Fig. 53L
upper molars, left



MD-116
NEVIUS
Fig. 88R



EXTRACTING FORCEPS (American Pattern)

- Щипцы экстракционные (американская форма)
- Daviers - forme américaine
- Fórceps de extracción - forma americana
- Щипці екстракційні (американська форма)
- Pinzeper per estrazione - forma americana
- استخراج الملقط (النمط الأمريكي)



MD-117
Fig. 24
upper molars



MD-118
210S
upper third molars



MD-119
210H
upper third molars



MD-120
286
Upper Roots,
Premolars, Incisors



MD-121
99C
Kells
upper incisors,
canines, premolars



MD-122
222
lower third molars



MD-123
286
Lower Molar

EXTRACTING FORCEPS (American Pattern)



- Щипцы экстракционные (американская форма)
- Daviers - forme américaine
- Fórceps de extracción - forma americana
- Щипці екстракційні (американська форма)
- Pinzere per estrazione - forma americana
- استخراج الملقط (النمط الأمريكي)



MD-124
Nevius
Fig. 88L
upper molars, left

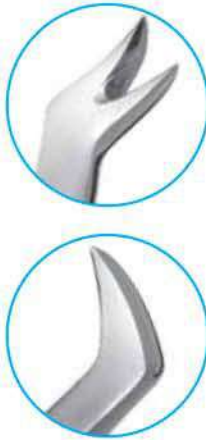

MD-125
Fig. 65
upper incisors
and roots



MD-126
Parmly Fig. 32A
upper premolars
and roots



MD-127
Parmly Fig. 32
upper premolars
and molars

EXTRACTING FORCEPS (American Pattern)

- Щипцы экстракционные (американская форма)
- Daviers - forme américaine
- Fórceps de extracción - forma americana
- Щипці екстракційні (американська форма)
- Pinzeper per estrazione - forma americana
- استخراج الملقط (النمط الأمريكي)



MD-128
COHEN
universal

MD-129
Fig. 203
lower incisors
and roots

MD-130
Tomes Fig. 69
upper and lower
roots

EXTRACTING FORCEPS (American Pattern)



- Щипцы экстракционные (американская форма)
- Daviers - forme américaine
- Fórceps de extracción - forma americana
- Щипці екстракційні (американська форма)
- Pinzere per estrazione - forma americana
- استخراج المنقط (النمط الأمريكي)



MD-131
Fig. 23
lower molars

MD-132
Fig. 16
lower molars



MD-133
Physic Fig. 5
lower third molars



MD-134
Harris Fig. 15
lower molars



MD-135
Fig. 103

EXTRACTING FORCEPS (American Pattern)

- Щипцы экстракционные (американская форма)
- Щипці екстракційні (американська форма)
- Daviers - forme américaine
- Pinzeper per estrazione - forma americana
- Fórceps de extracción - forma americana
- استخراج الملقط (النمط الأمريكي)



MD-136
Hull
Fig. 101
Deciduous teeth

MD-137
Cryer
Fig. 150S
upper teeth,
for children

MD-138
Fig. 150 AS

EXTRACTING FORCEPS (American Pattern)



- Щипцы экстракционные (американская форма)
- Daviers - forme américaine
- Fórceps de extracción - forma americana
- Щипці екстракційні (американська форма)
- Pinzere per estrazione - forma americana
- استخراج الملقط (النمط الأمريكي)



MD-139
Cryer
Fig. 151
lower teeth,
for children

MD-140
Fig. 151 S
lower incisors,
premolars, roots

MD-141
Fig. 151 AS

EXTRACTING FORCEPS (American Pattern)

- Щипцы экстракционные (американская форма)
- Daviers - forme américaine
- Fórceps de extracción - forma americana
- Щипці екстракційні (американська форма)
- Pinzere per estrazione - forma americana
- استخراج الملقط (النمط الأمريكي)



MD-142
16S
lower molars for children



MD-143
17S
lower molars



MD-144
23 S
Lower molars

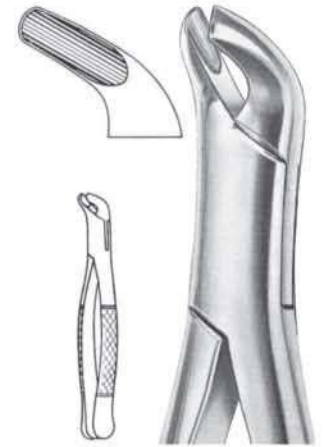

MD-145
27
lower molars



MD-146
18LS
upper molars left



MD-147
18RS
upper molars right



MD-148
85 Tomas
lower canines, premolars and molars

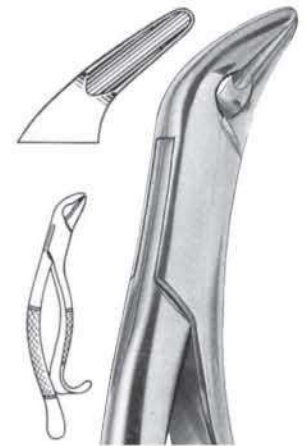

MD-149
85A Tomas
lower canines, premolars and molars



MD-150
69S
upper and lower roots



MD-151
99A Kells
upper incisors, canines, premolars

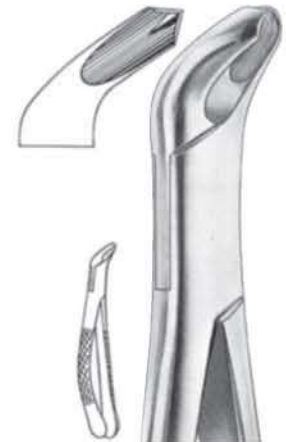

MD-152
217
lower molars

EXTRACTING FORCEPS (American Pattern)



- Щипцы экстракционные (американская форма)
- Daviers - forme américaine
- Férceps de extracción - forma americana
- Щипці екстракційні (американська форма)
- Pinzere per estrazione - forma americana
- استخراج الملقط (النمط الأمريكي)



MD-153
#10 SK
Upper Molars Sup



MD-154
#17 SK Universal
Lower Molars



MD-155
#23 SK Universal
Upper Molars



MD-156
#69 SK Tomas
upper and lower roots



MD-157
#99 SK
upper incisors,
canines, premolars



MD-158
#150 SK
upper incisors,
premolars, roots



MD-159
#151 SK
lower incisors,
premolars, roots



MD-160
#222 SK
lower third molars

- Щипцы экстракционные (американская форма)
- Daviers - forme américaine
- Fórceps de extracción - forma americana
- Щипці екстракційні (американська форма)
- Pinzeper per estrazione - forma americana
- استخراج الملقط (النمط الأمريكي)



MD-161
Fig. 1
Upper Anterior

MD-162
Lower Molar
Fig. 23 Cow Horn



MD-163
Fig. 74
Lower Anterior



MD-164
Fig. 88L
Upper Molar Left



MD-165
Fig. 88R
Upper Molar Right



MD-166
Fig. 74
Lower Anterior



MD-167
Fig. 106
Lower Incisors



MD-168
Fig. 174
Extra Narrow
Lower Anterior
Apical Retention
Forceps



MD-169
Fig. 859
Lower Molars
Roots



EXTRACTING FORCEPS (American Pattern)



- Щипцы экстракционные (американская форма)
- Щипці екстракційні (американська форма)
- Daviers - forme américaine
- Pinzere per estrazione - forma americana
- Fórceps de extracción - forma americana
- استخراج الملقط (النمط الأمريكي)

Carbide Diamond Coated Point



MD-170
150 T.C.
Carbide Serrated Beak
Upper Incisors, Cuspids,
Bicuspid & Roots,
Universal



MD-171
151 T.C.
Carbide Serrated Beak
Lower Incisors, Cuspids,
Bicuspid & Roots, Universal



MD-172
1STD T.C.
Carbide Serrated Beak
Upper Incisors, Cuspids,



MD-173
17 T.C.
Carbide Serrated Beak
1st & 2nd Lower Molars,
Universal



MD-174
53L T.C.
Carbide Serrated Beak
1st & 2nd Upper Molars,
Left



MD-175
53R T.C.
Carbide Serrated Beak
1st & 2nd Upper Molars,
Right



MD-176
65 T.C.
Carbide Serrated Beak
Upper Incisors, Roots &
Fragments



MD-177
69 T.C.
Carbide Serrated Beak
Upper & Lower Fragments
And Roots



MD-178
150S T.C. Pedro forcep
Carbide Serrated Beak
Pedo, Upper Primary Teeth
and Roots, Universal



MD-179
151S T.C. Pedro forcep
Carbide Serrated Beak
Pedo, Lower Primary Teeth
and Roots, Universal

BONE ROUNGER

- Костные кусачки
- Hohlmeißelzangen
- Pincès-gouges
- Кусачки для кісток
- Pinzas-gubias
- روتجیورس العظام



MD-180
Blumenthal
15cm



MD-181
Blumenthal
15cm



MD-182
Blumenthal
15cm



MD-183
Friedman
14cm



MD-184
Friedman
14.5cm



MD-185
Micro-Friedman
14cm



MD-186
Micro-Friedman
15cm



MD-187
Micro-Friedman
16cm



MD-188
Kleinert-Kutz
18.5cm



MD-189
Beyer
18.5cm



MD-190
Mead 1A
18.5cm



MD-191
Luer
18.5cm

EXTRACTING FORCEPS (English Pattern)



- Щипцы экстракционные (английская форма)
- Daviers (Forme Anglaise)
- Zahnzangen (Englische Form)
- Щипці екстракційні (англійська форма)
- Forceps de Extracción (Forme Inglesa)
- استخراج الملقط (نمط اللغة الإنجليزية)

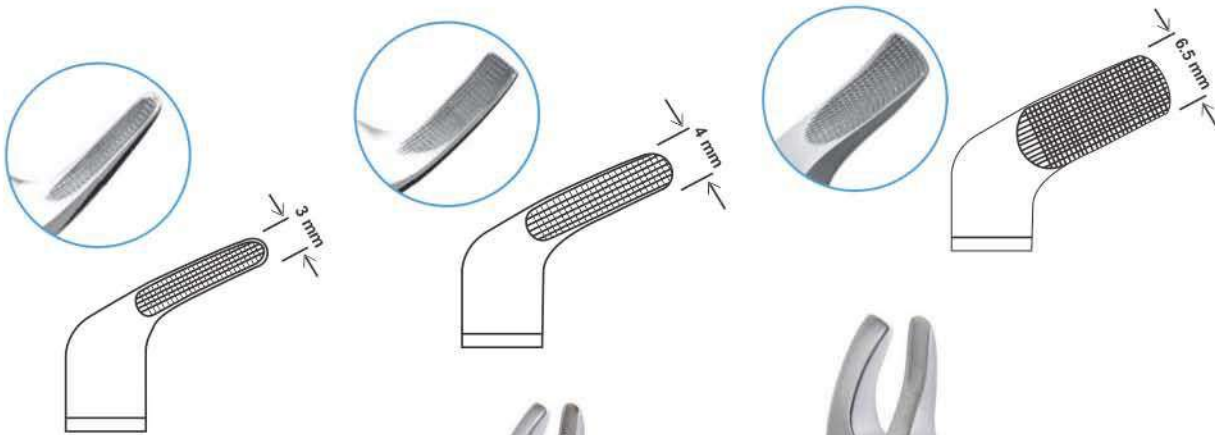

MD-192
Meissner
Extracting Forceps



MD-193
Meissner
Extracting Forceps



MD-194
Meissner
Extracting Forceps



MD-195
Comellas Forceps
Anatomical Handle

- Шприцы стоматологические карпульные
- Шприці стоматологічні карпульні
- Seringues à usage dentaire
- Jeringas dentales
- Dentalspritzen
- المحاقن الأسنان



MD-196 1.8ml
MD-197 2.2ml



MD-198 1.8ml
MD-199 2.2ml



MD-200 1.8ml
MD-201 2.2ml



MD-202 1.8ml
MD-203 2.2ml



MD-204 1.8ml
MD-205 2.2ml



MD-206 1.8ml
MD-207 2.2ml



MD-208
1001
Intraligamental
Anesthesia
Syringe in
Black Colour



MD-209 1.8ml
MD-210 2.2ml
Angled



MD-211
Aluminium - Dark 1.8 ml



MD-212 Aluminium - Silver 1.8 ml
MD-213 Aluminium - Orange 1.8 ml
MD-214 Aluminium - Green 1.8 ml
MD-215 Aluminium - Blue 1.8 ml



Type C
MD-216 1.8ml
MD-217 2.2ml



Type C
MD-218 1.8ml
MD-219 2.2ml



2-Ring
MD-220 1.8ml
MD-221 2.2ml



Aspirating Syringe
MD-222 1.8ml
MD-223 2.2ml



Cartridge Syringe
MD-224 1.8ml
MD-225 2.2ml



Cartridge Syringe
MD-226 1.8ml
MD-227 2.2ml



Cartridge Syringe
MD-228 1.8ml
MD-229 2.2ml

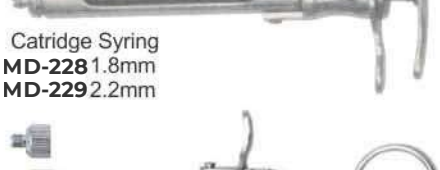

Euro Breech loading
MD-230 1.8ml
MD-231 2.2ml

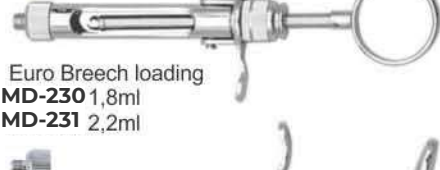

EuroBreech loading
MD-232 1.8ml
MD-233 2.2ml



Manual Aspirating Syringe
MD-034 1.8ml
MD-235 2.2ml



Quatro
MD-236 1.8ml
MD-237 2.2ml



Trio
MD-238 1.8ml
MD-239 2.2ml

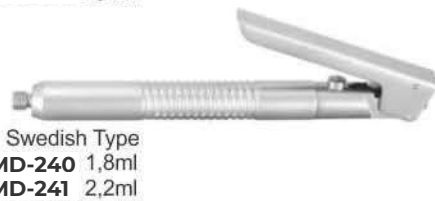

Swedish Type
MD-240 1.8ml
MD-241 2.2ml



Ject Ultima
MD-242 1.8ml
MD-243 2.2ml
Injects 0.05 ml with every click
Supplied with angled and straight tubes



Ject angled
MD-244 1.8ml
MD-245 2.2ml



Ject straight
MD-246 1.8ml
MD-247 2.2ml



Disc System
MD-248 1.8ml
MD-249 2.2ml



Disc System
MD-250 1.8ml

EXTRACTING FORCEPS SET



Извлечение щипцов
Ensemble de pinces d'extraction
• Zange sammeln

• Витягуючий комплект щипців
• Extracción del conjunto de fórceps
• استخراج ملقط مجموعة



MD-251
Extracting Forceps
Set of 10 Pieces
Extracting Forceps Fig. 2
Extracting Forceps Fig. 7
Extracting Forceps Fig. 13
Extracting Forceps Fig. 17
Extracting Forceps Fig. 18
Extracting Forceps Fig. 22
Extracting Forceps Fig. 33
Extracting Forceps Fig. 51A
Extracting Forceps Fig. 67A
Extracting Forceps Fig. 79

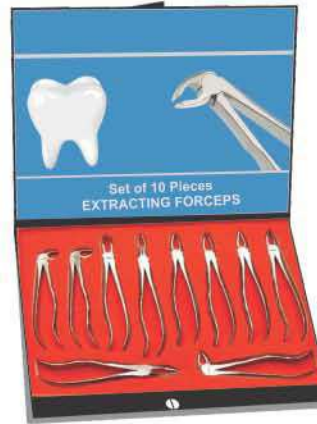

MD-252
Extracting Forceps
Set of 10 Pieces (Anatomical Handle)
Extracting Forceps Fig. 2
Extracting Forceps Fig. 7
Extracting Forceps Fig. 13
Extracting Forceps Fig. 17
Extracting Forceps Fig. 18
Extracting Forceps Fig. 22
Extracting Forceps Fig. 33
Extracting Forceps Fig. 51A
Extracting Forceps Fig. 67A
Extracting Forceps Fig. 79



MD-253
Extracting Forceps
Set of 13 Pieces
Extracting Forceps Fig. 2
Extracting Forceps Fig. 7
Extracting Forceps Fig. 13
Extracting Forceps Fig. 17
Extracting Forceps Fig. 18
Extracting Forceps Fig. 22
Extracting Forceps Fig. 33
Extracting Forceps Fig. 51A
Extracting Forceps Fig. 67A
Extracting Forceps Fig. 79
Extracting Forceps Fig. 86C
Extracting Forceps Fig. 89
Extracting Forceps Fig. 90



MD-254
Extracting Forceps Children Pattern
Set of 10 Pieces
Extracting Forceps Fig. 13S
Extracting Forceps Fig. 22S
Extracting Forceps Fig. 30S
Extracting Forceps Fig. 33S
Extracting Forceps Fig. 37
Extracting Forceps Fig. 38
Extracting Forceps Fig. 39
Extracting Forceps Fig. 39L
Extracting Forceps Fig. 39R
Extracting Forceps Fig. 51S



MD-255
Extracting Forceps English adult Adult
Set of 10 Pcs



MD-256
Extracting Forceps American Adult
Set of 10 Pcs



MD-257
Extracting Forceps American Adult
Set of 8 Pcs



MD-258
Extracting Forceps Pedro
Set of 7 Pcs

FUNCTION OF ROOT ELEVATORS IN SURGERY

To Loosen Tooth or Root From Bony Socket Prior to Placement of The Extraction Forceps.

HANDLES FOR ROOT ELEVATORS POINTS A, B, C, D, E, F, G, H

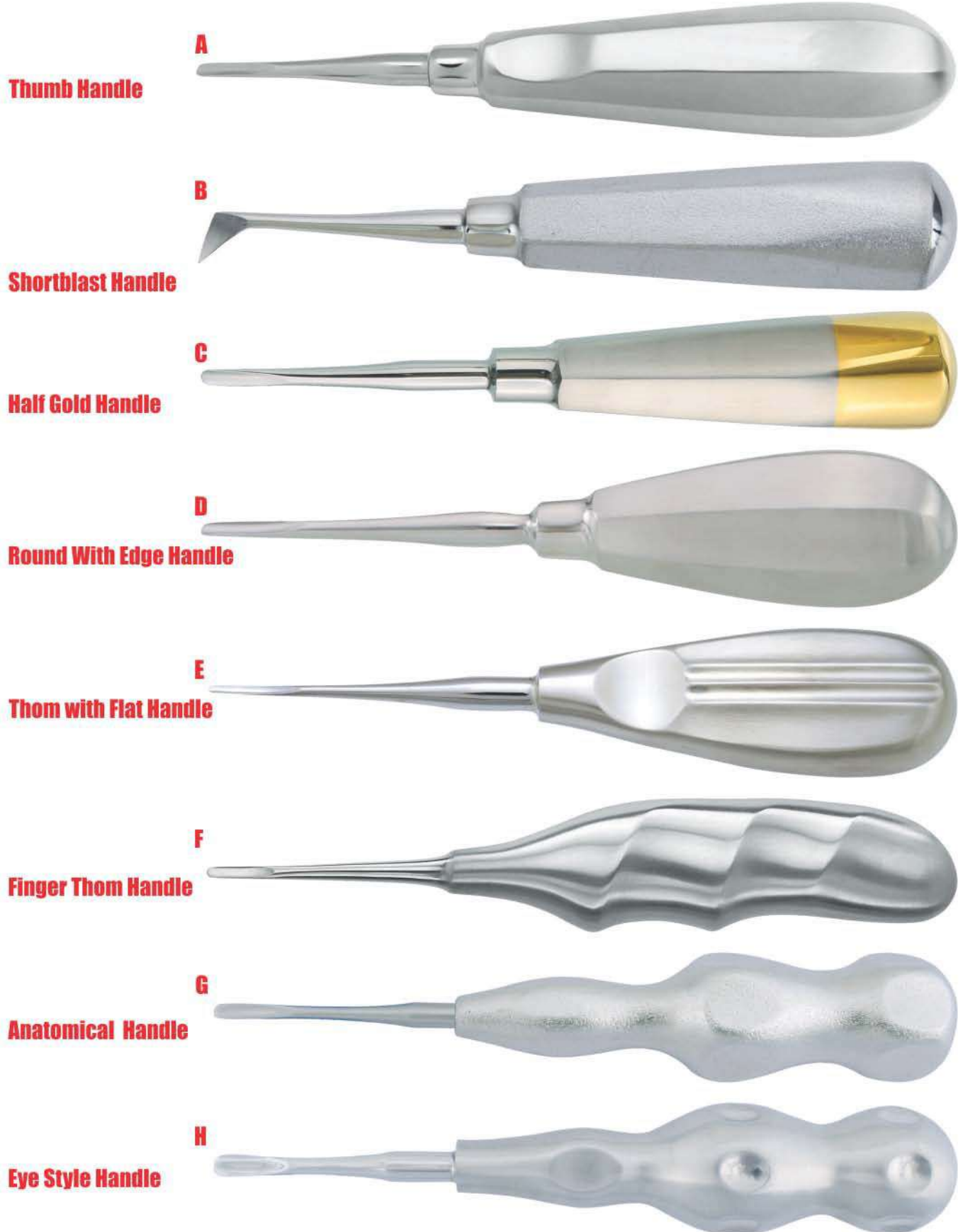

ROOT ELEVATOR



- Элеватор корневой экстракционный
- Elévateurs à racines
- Wurzelheber
- Слеватор корневий экстракційний
- Elevadores para raices
- المصاعد الجذر

Function of Root Elevators:

To loosen tooth or root from bony socket prior to placement of the extraction forceps.

Apexo Root Elevators



Apexo



Luxator Root Elevators



Luxator



upper root elevator



upper root elevator



Upper root elevator with helicoidal tip

Bein Root Elevators



Bein

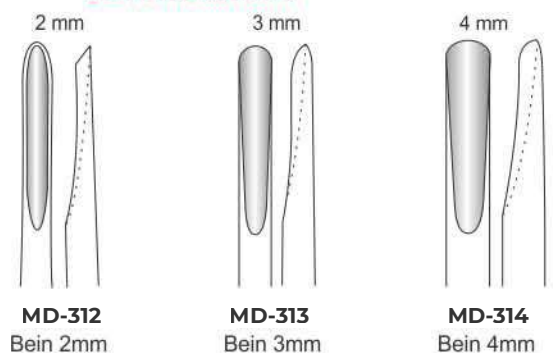

Seldin Root Elevators



Seldin

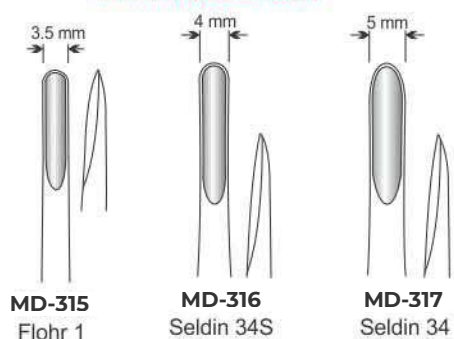

ROOT ELEVATOR

- Элеватор корневой экстракционный
- Elévateurs à racines
- Wurzelheber
- Слеватор корневий экстракційний
- Elevadores para raices
- المصاعد الجذر

FUNCTION: To loosen tooth or root from bony socket prior to placement of the extraction forceps.

Laxutor Root Elevators

Long Type



Laxutor Root Elevator



MD-318
Laxutor
1.5mm
Str.



MD-319
Laxutor
2mm
Str.



MD-320
Laxutor
3mm
Str.



MD-321
Laxutor
5mm
Str.



MD-322
Laxutor
3mm
Cvd.



MD-323
Laxutor
5mm
Cvd.



MD-324
Laxutor
3mm
Upper Angle



MD-325
Laxutor
3mm
Double Angle



MD-326
Laxutor
3mm
Str.



MD-327
Laxutor
5mm
Str.



ROOT ELEVATOR



- Элеватор корневой экстракционный
- Elévateurs à racines
- Wurzelheber
- Слеватор корневий екстракційний
- Elevadores para raices
- المعصاعد الجذر

Laxator Root Elevators



lower roots elevator



Upper root elevator with helicoidal tip

Luxator Roots Elevator



Function of Root Elevators:

To loosen tooth or root from bony socket prior to placement of the extraction forceps.

Apical Root Elevators

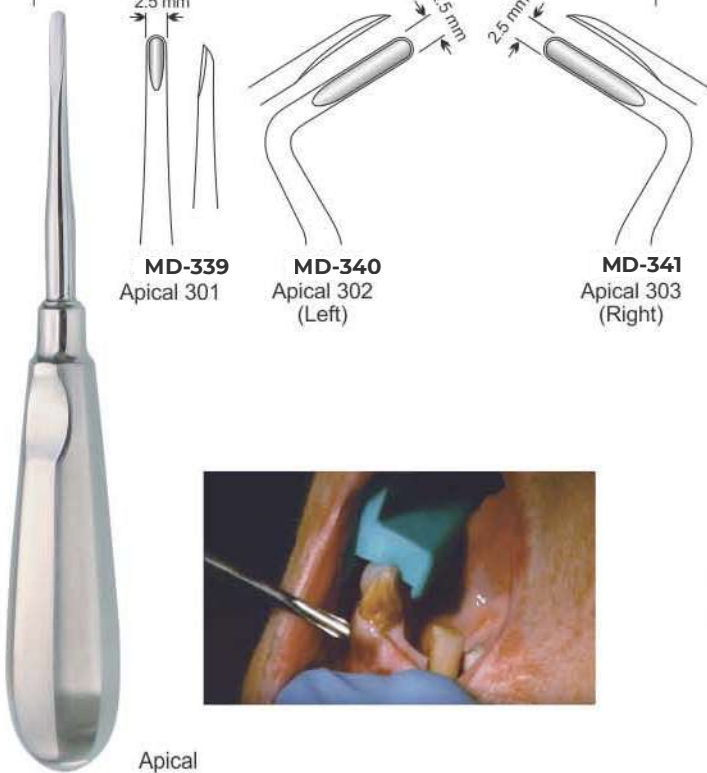

Apical Root Elevators

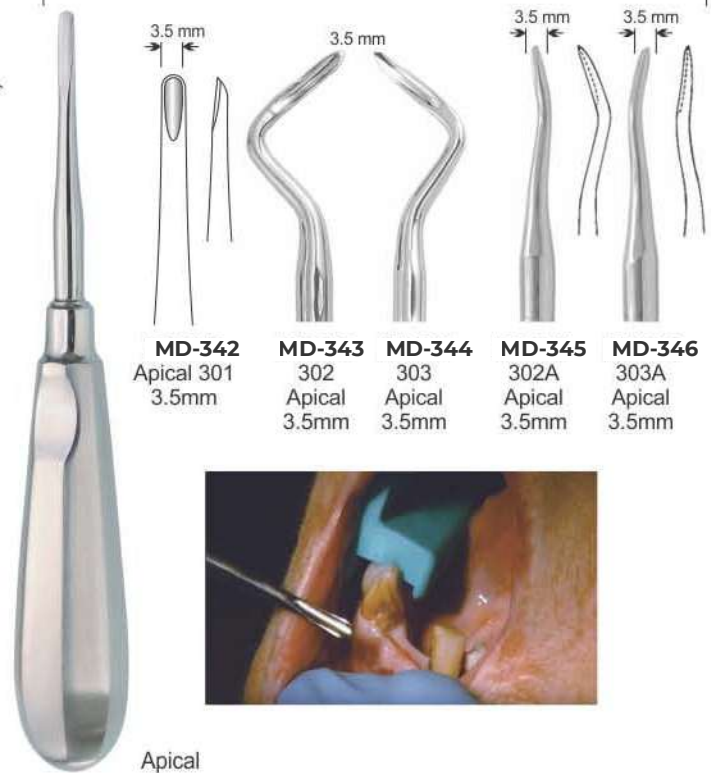

ROOT ELEVATOR

- Элеватор корневой экстракционный
- Elévateurs à racines
- Wurzelheber
- Слеватор корневий экстракційний
- Elevadores para raices
- المصاعد الجذر

FUNCTION: To Loosen Tooth or Root From Bony Socket Prior to Placement of The Extraction Forceps.

Cryer Root Elevators

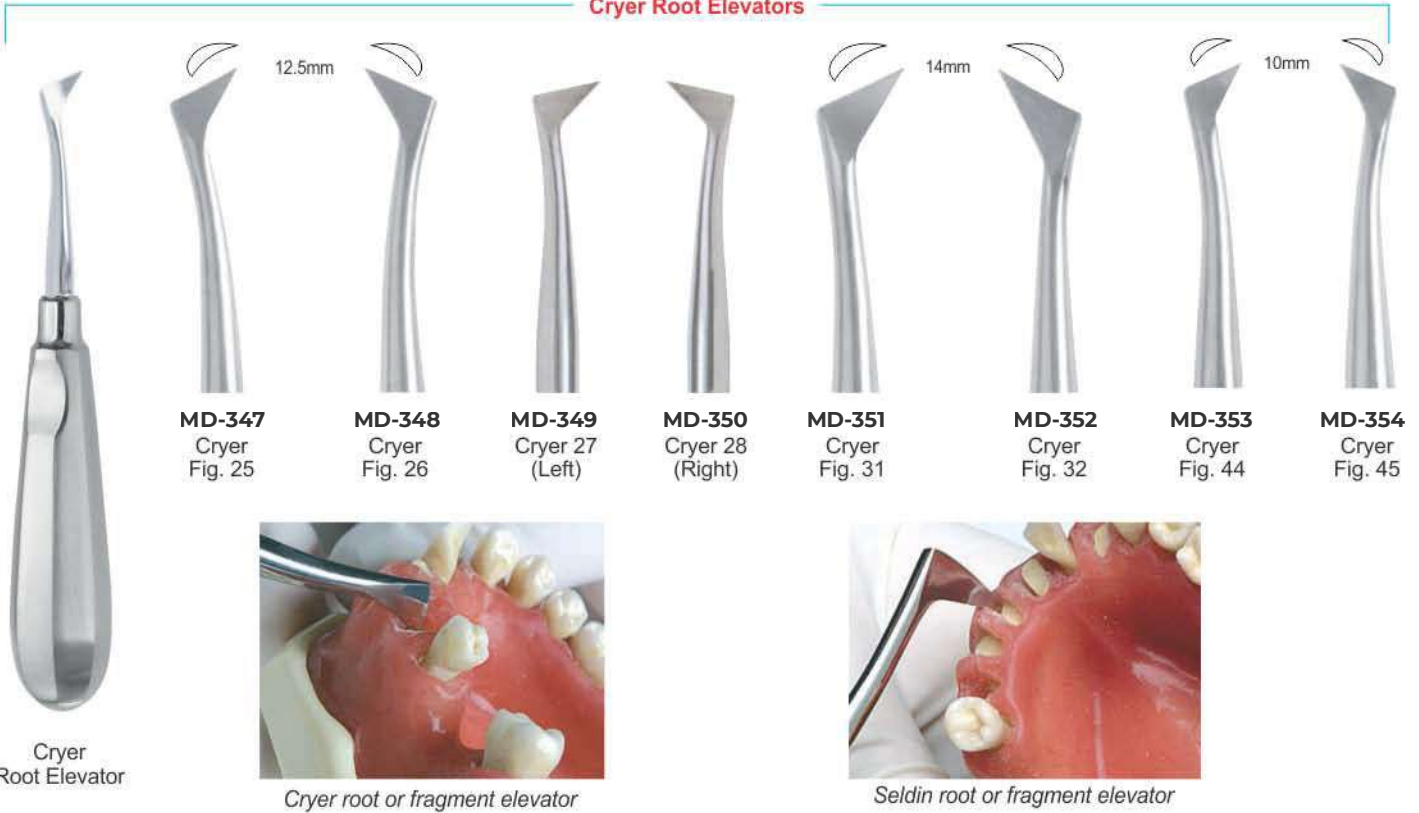

Seldin Root Elevators

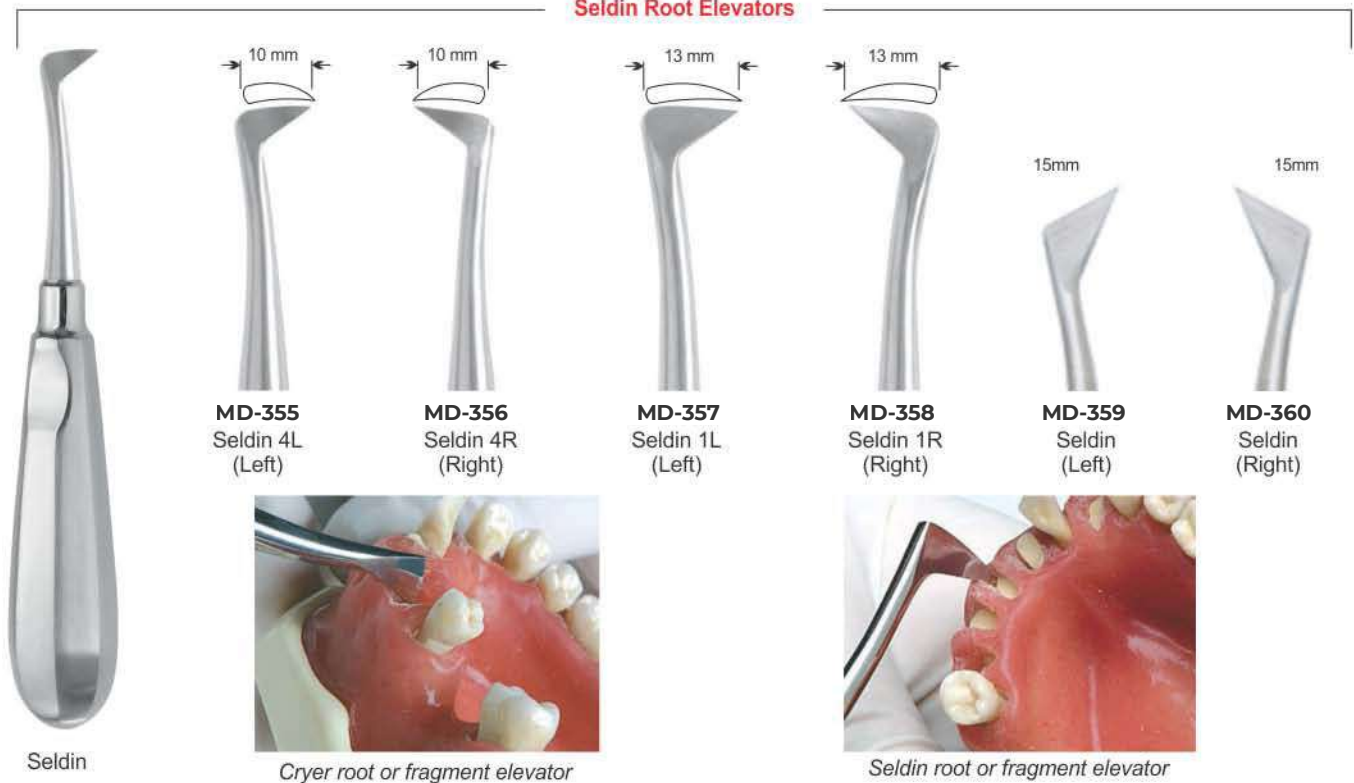

ROOT ELEVATOR



- Элеватор корневой экстракционный
- Elévateurs à racines
- Wurzelheber
- Слеватор кореневий экстракційний
- Elevadores para raices
- المصاعد الجذر

FUNCTION: To Loosen Tooth or Root From Bony Socket Prior to Placement of The Extraction Forceps.

Apical Root Elevators

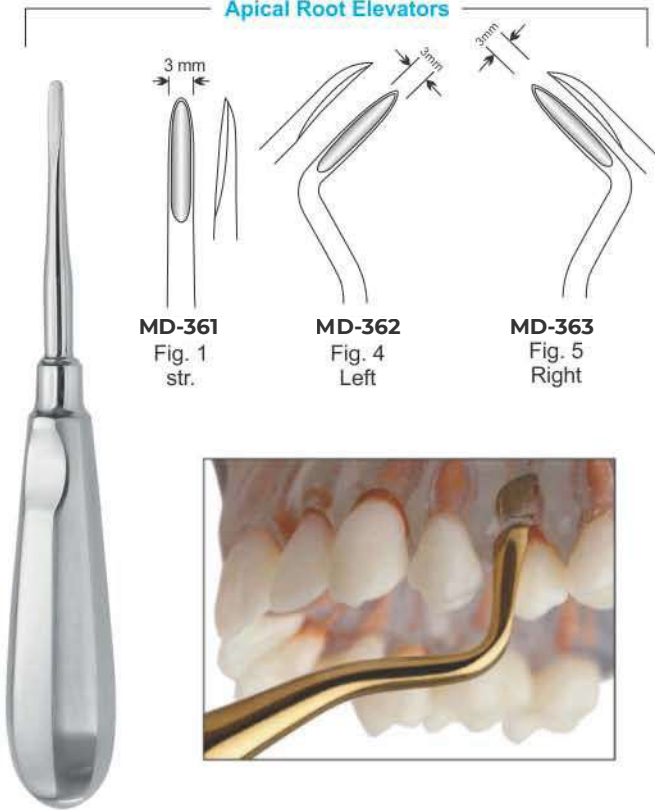

Apical Root Elevators

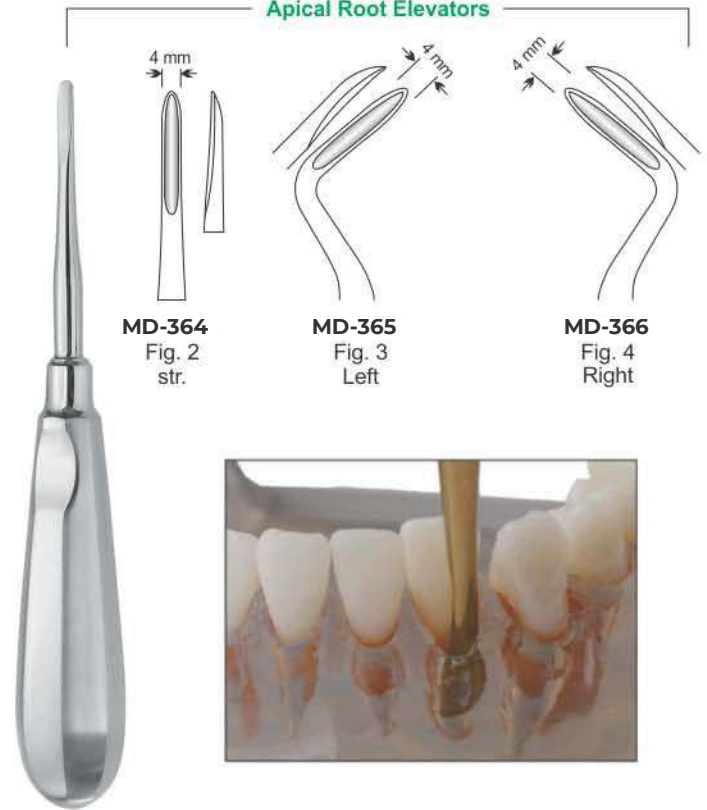

Flohr Root Elevators



Heidbrink Root Elevators

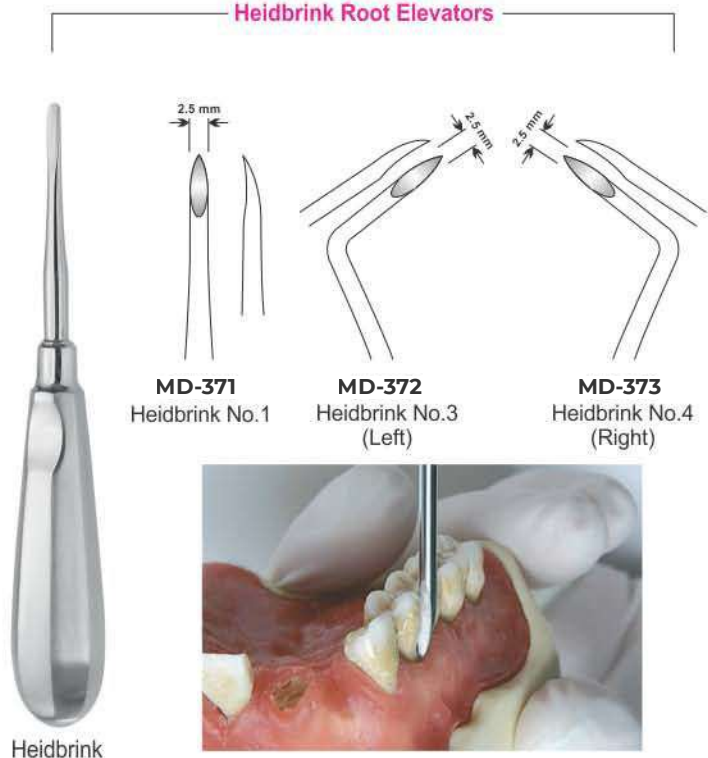

ROOT ELEVATOR

- Элеватор корневой экстракционный
- Elévateurs à racines
- Wurzelheber
- Слеватор корневий экстракційний
- Elevadores para raices
- المصاعد الجذر

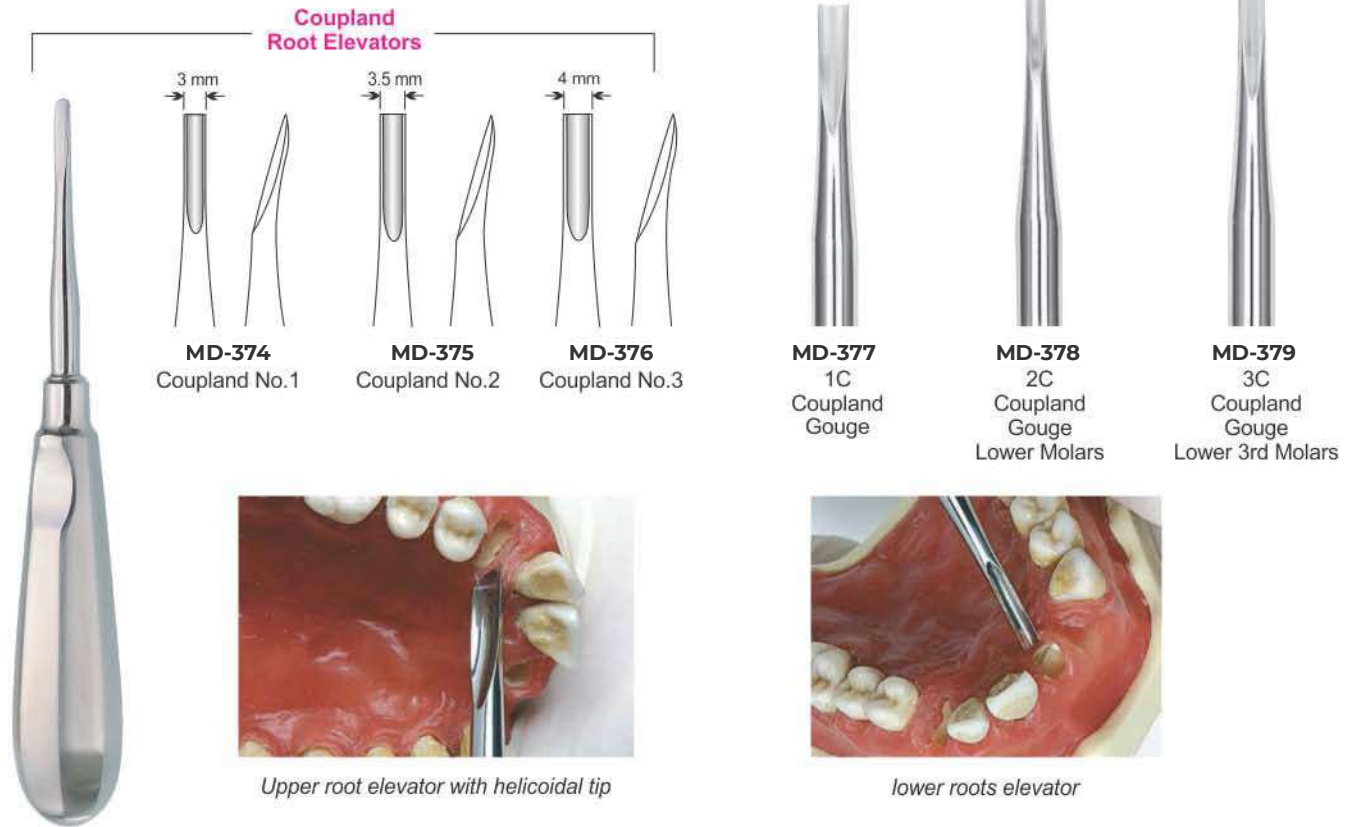

FUNCTION: To Loosen Tooth or Root From Bony Socket Prior to Placement of The Extraction Forceps.

ENGLISH PATTERNS



ROOT ELEVATOR



- Элеватор корневой экстракционный
- Elévateurs à racines
- Wurzelheber
- Слеватор корневий экстракційний
- Elevadores para raices
- المصاعد الجذر

Lindo Levian Root Elevators



MD-393
Lindo-Levian Serrated Curved

MD-394
Lindo-Levian Serrated Right

Function of Root Elevators:

To loosen tooth or root from bony socket prior to placement of the extraction forceps.



ROOT ELEVATOR

- Элеватор корневой экстракционный
- Elévateurs à racines
- Wurzelheber
- Слеватор корневий экстракційний
- Elevadores para raices
- المصاعد الجذر

Friedmann Roots Elevator



MD-402
Friedmann 4F
Str.

MD-403
Friedmann 5F
Left

MD-404
Friedmann 6F
Right

Luxating Elevator With Periotome Tip



MD-405
3mm Luxating
Elevator / Periotome

MD-406
4mm Luxating
Elevator / Periotome

MD-407
5mm Luxating
Elevator / Periotome

Wisdom Roots Elevator



MD-408
Wisdom
for 18 and 38

MD-409
Wisdom
for 28 and 48

Function of Root Elevators: To loosen tooth or root from bony socket prior to placement of the extraction forceps.

Bayonet Roots Elevator Set



MD-410
Left

MD-411
Right

MD-412
bayonet

MD-413
Curved

MD-414
Straight

ROOT ELEVATOR



- Элеватор корневой экстракционный
- Elévateurs à racines
- Wurzelheber
- Слеватор корневий екстракційний
- Elevadores para raices
- المصاعد الجذر

Miller Root Elevators

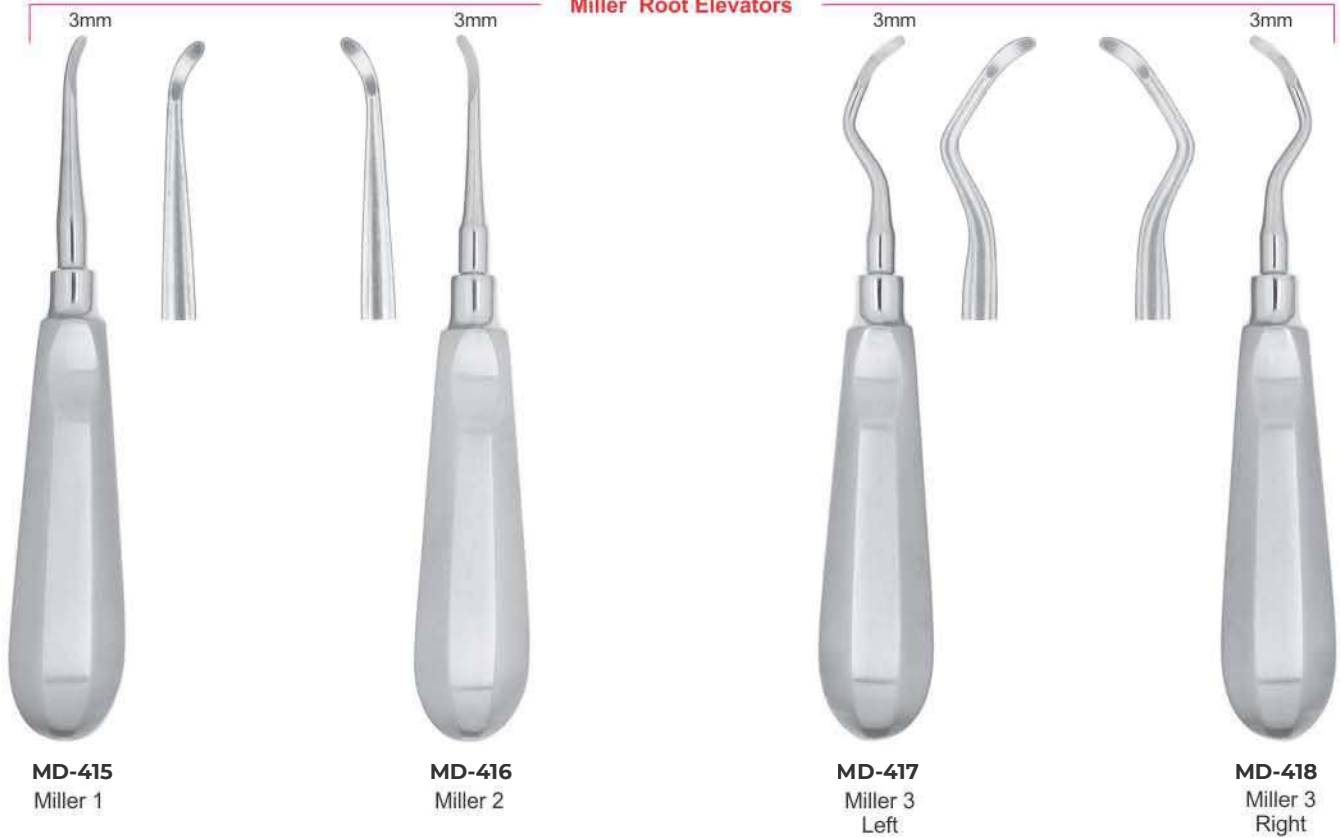

Function of Root Elevators: To loosen tooth or root from bony socket prior to placement of the extraction forceps.

Claw-Lift Roots Elevator

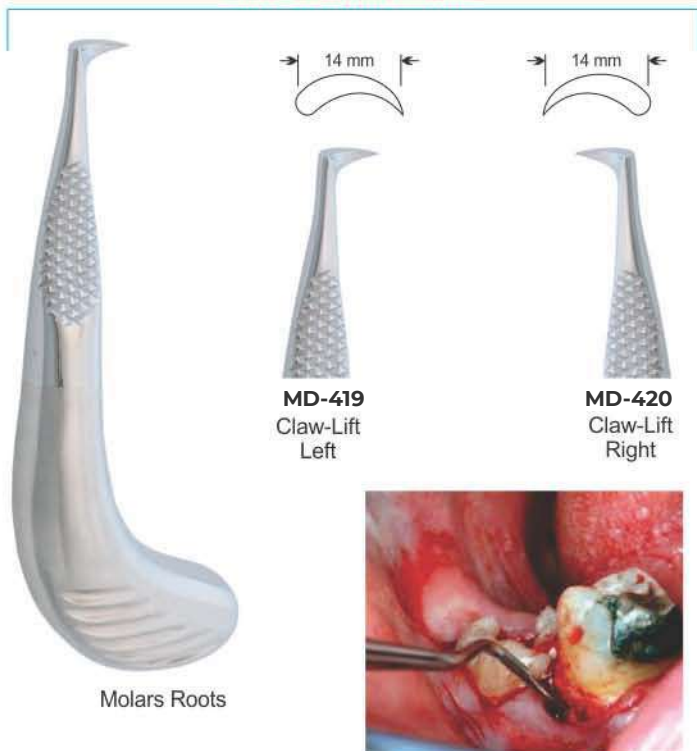

Schlemmer Roots Elevator



ROOT ELEVATOR

- Элеватор корневой экстракционный
- Elévateurs à racines
- Wurzelheber
- Слеватор корневий екстракційний
- Elevadores para raices
- المصاعد الجذر

FUNCTION: To Loosen Tooth or Root From Bony Socket Prior to Placement of The Extraction Forceps.

Laxutor Root Elevators Set of 9 Pcs



MD-424
2mm Str.



MD-425
3mm Str.



MD-426
5mm Str.



MD-427
3mm Cvd.



MD-428
5mm Cvd.



MD-429
3mm Angle



MD-430
3mm Angle



MD-431
3mm Str.



MD-432
5mm Str.



ROOT ELEVATOR

- Элеватор корневой экстракционный
- Elévateurs à racines
- Wurzelheber
- Слеватор корневий екстракційний
- Elevadores para raices
- المصاعد الجذر

Hylin Roots Elevator



Function of Root Elevators: To loosen tooth or root from bony socket prior to placement of the extraction forceps.

Kopp Roots Elevator

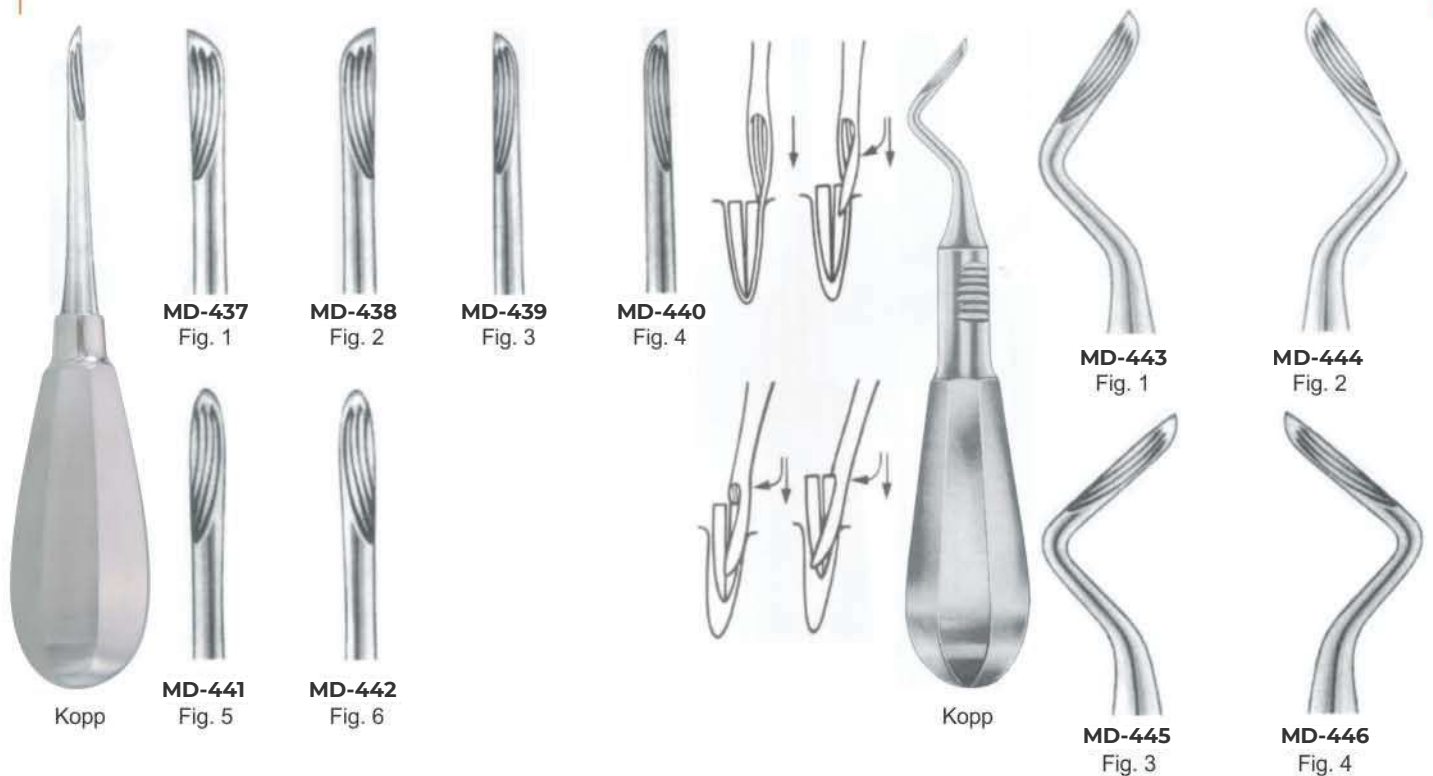

ROOT ELEVATOR

- Элеватор корневой экстракционный
- Elévateurs à racines
- Wurzelheber
- Слеватор кореневий екстракційний
- Elevadores para raices
- المصاعد الجذر

Luxier Roots Elevator



MD-447
Luxier
Cvd.

MD-448
Luxier
Str.

Heber Roots Elevator



MD-449
Heber
Bayonet

MD-450
Heber
Bayonet

Bein Roots Elevator



MD-451
Bein,
3mm

MD-452
Bein,
4mm

Function of Root Elevators: To loosen tooth or root from bony socket prior to placement of the extraction forceps.

Bein Roots Elevator



MD-453
Bein
2mm, curved
serrated



MD-454
2mm
straight
serrated

MD-455
3mm
straight

MD-456
4mm
Curved



MD-457
Bein
2mm, curved
serrated



MD-458
2mm
straight
serrated

MD-459
3mm
straight

MD-460
4mm
Curved



MD-461
Bein
2mm, curved
serrated



MD-462
2mm
straight
serrated

MD-463
3mm
straight

MD-464
4mm
Curved

ROOT ELEVATOR



- Элеватор корневой экстракционный
- Elévateurs à racines
- Wurzelheber
- Слеватор корневий экстракційний
- Elevadores para raices
- المصاعد الجذر

W. Barry Roots Elevator



W. Barry
Fig. 1
(125mm)



MD-465
W. Barry
Fig. 1

MD-466
W. Barry
Fig. 2

MD-467
W. Barry
Fig. 3

MD-468
W. Barry
Fig. 4

Function of Root Elevators: To loosen tooth or root from bony socket prior to placement of the extraction forceps.



MD-469
Winter
Fig. 1L

MD-470
Winter
Fig. 1R

MD-471
775/3
Winter
11 L

MD-472
775/4
Winter
11 R

MD-473
775/5
Winter
12 L

MD-474
775/6
Winter
12 R

MD-475
775/7
Winter
13 L

MD-476
775/8
Winter
13 R

Winter
Fig. 1L
125mm

MD-477
Winter
Fig. 1L

MD-478
Winter
Fig. 1R

MD-479
Lecluse
bayonet

MD-480
Potts "T-Handle"
Elevator-Left

MD-481
Potts "T-Handle"
Elevator-Right

ROOT ELEVATOR

- Элеватор корневой экстракционный
- Elévateurs à racines
- Wurzelheber
- Слеватор корневий екстракційний
- Elevadores para raices
- المصاعد الجذر



MD-482
Fig. 1
Chompret



MD-483
Fig. 2
Chompret



MD-484
Fig. 3
Chompret



MD-485
Fig. 4
Chompret



Lecluse elevator for lower third molar dislocation



Chompret syndesmotome, sickle pattern



MD-486



MD-487



MD-488



MD-489



MD-490



MD-491



MD-492

Root Pick Elevator With Gold Flexible Points

ROOT ELEVATOR



- Элеватор корневой экстракционный
- Elévateurs à racines
- Wurzelheber
- Слеватор корневий экстракційний
- Elevadores para raices
- المصاعد الجذر

Heidbrink Roots Elevator



MD-493
Heidbrink
Straight

MD-494
Heidbrink
Left

MD-495
Heidbrink
Right

MD-496
Heidbrink
Straight

MD-497
Heidbrink
Left

MD-498
Heidbrink
Right

Syndesmotomes Roots Elevator



MD-499
Straight

MD-500
Left

MD-501
Right

Periotome Roots Elevator



MD-502
Periotome
2.1mm
Straight

MD-503
Periotome
2.6mm
Straight

MD-504
Periotome
2.1mm
Angular

MD-505
Periotome
2mm
Curved

MD-506
Periotome
2.0mm

MD-507
Periotome
2.5mm

MD-508
Periotome
3.0mm

MD-509
Periotome
4.0mm

Syndesmotomes

ROOT ELEVATOR

- Элеватор корневой экстракционный
- Elévateurs à racines
- Wurzelheber
- Слеватор корневий экстракційний
- Elevadores para raices
- المصاعد الجذر

FUNCTION: To loosen small root fragments from bony socket

Heidbrink Roots Elevator

Warwick-James

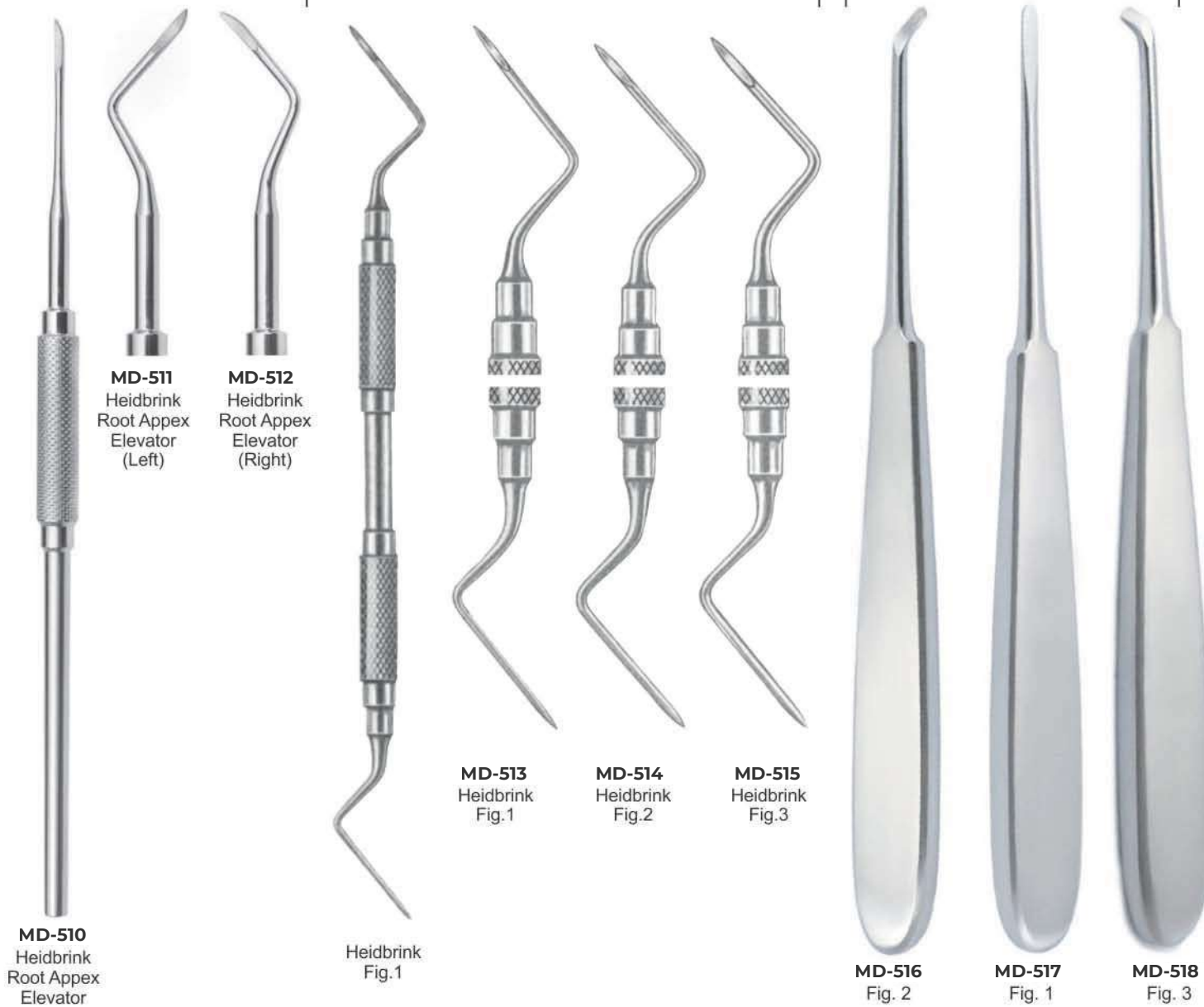

ROOT ELEVATOR



- Элеватор корневой экстракционный
- Elévateurs à racines
- Wurzelheber
- Слеватор корневий екстракційний
- Elevadores para raices
- المصاعد الجذر



MD-519
1S
(Straight 1mm)



MD-520
2S
(Straight 2mm)



MD-521
3S
(Straight 3mm)



MD-522
5S
(Straight 5mm)



MD-523
3C
(Curved 3mm)



MD-524
5C
(Curved 5mm)



MD-525
3CA
(Curved Angle 3mm)



MD-526
3IC
(Inverted Curved 3mm)



MD-527
DE 3
(Dual Edge 3mm / 1.5mm)



MD-528
DE 5
(Dual Edge 5mm / 3mm)

ROOT ELEVATOR

- Элеватор корневой экстракционный
- Elévateurs à racines
- Wurzelheber
- Слеватор корневий екстракційний
- Elevadores para raices
- المصاعد الجذر

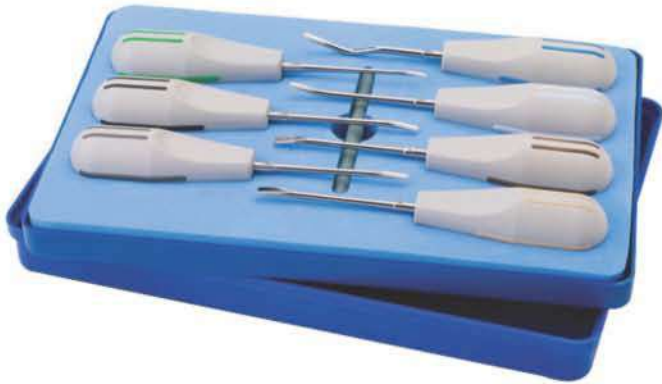

MD-529
Luxators Set of 7 Pcs

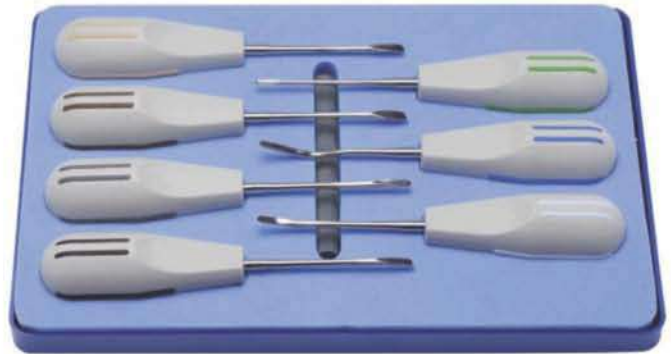

MD-530
Luxators Set of 7 Pcs



MD-531
Luxators Set of 8 Pcs



MD-532
Root Elevators Set of 10 Pcs



MD-533
Elevators Set of 8 Pcs



MD-534
Elevators Set of 8 Pcs

ROOT ELEVATOR



- Элеватор корневой экстракционный
- Elévateurs à racines
- Wurzelheber
- Elevator corneviu extracționii
- Elevadores para raices
- المصاعد الجذر

PDL ELEVATORS

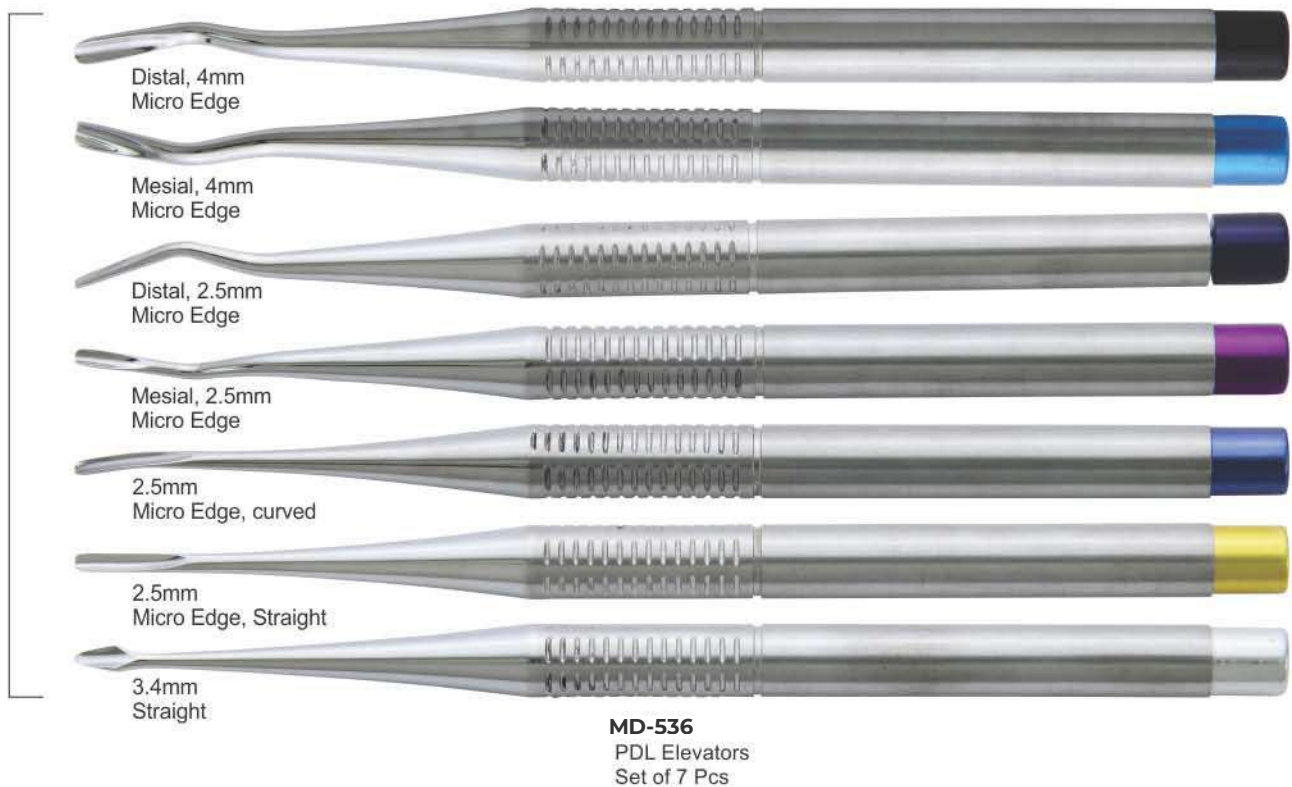
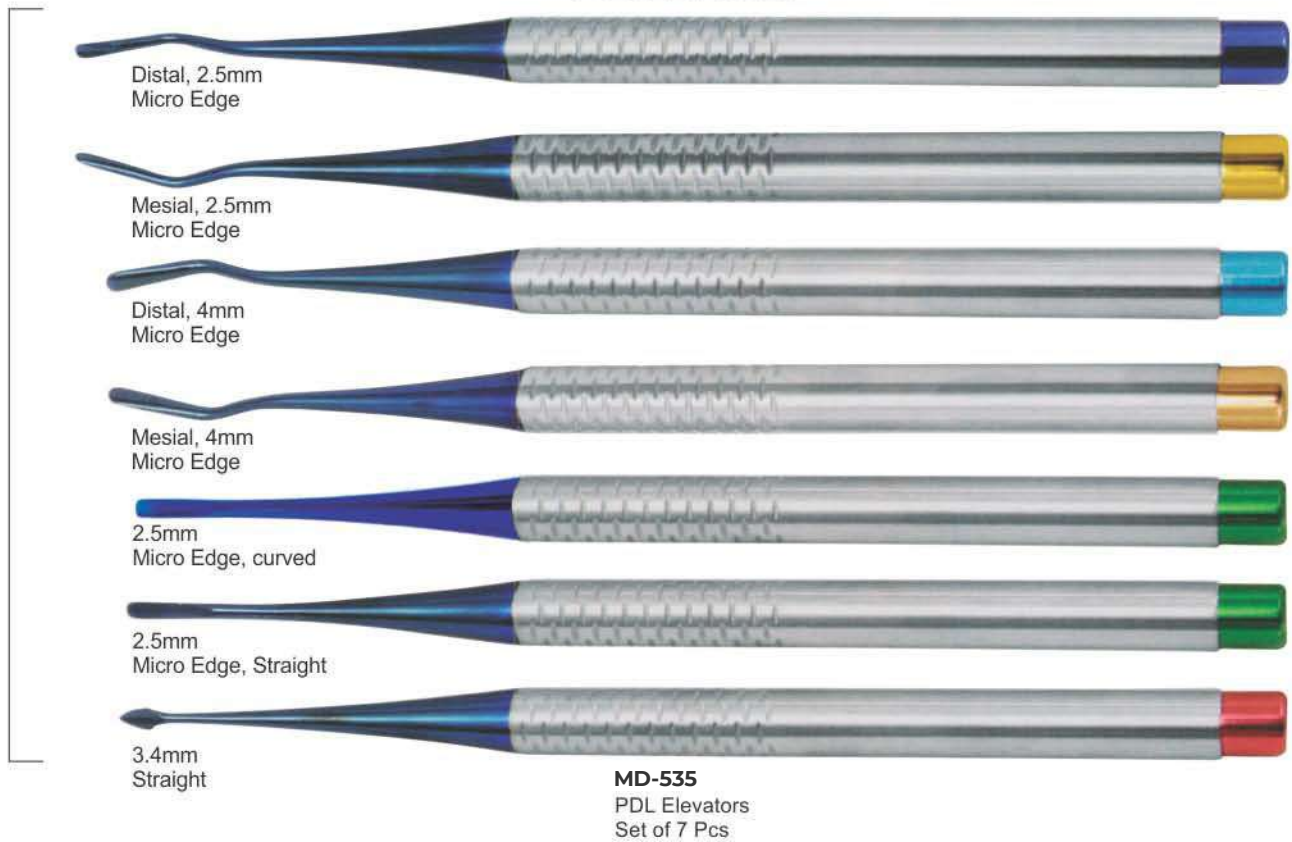

ROOT ELEVATOR

- Элеватор корневой экстракционный
- Elévateurs à racines
- Wurzelheber
- Слеватор кореневий екстракційний
- Elevadores para raices
- المصاعد الجذر

PDL ELEVATORS

Delicate Arrow tip



4,0mm straight 4,0mm curved

Luxivators straight atraumatic luxation of the tooth



2,5mm straight 3,5mm straight 4,5mm straight

Luxivators curved atraumatic luxation of the tooth



2,5mm curved 3,5mm curved 4,5mm curved



MD-537
PDL Elevators
Set of 8 Pcs

Our Scalers

Compare our scalers and curettes with the best in the industry and you will immediately recognize we are equal in every way but one... price. Note the deep precision knurling for better tactile feel. The same high-grade stainless steel tips, the same light weight (under 18 grams) for less hand fatigue, the same professional craftsmanship, and surpassing the highest industry standards. of course, any manufacturer can make these claims, but we guarantee and certify ours.

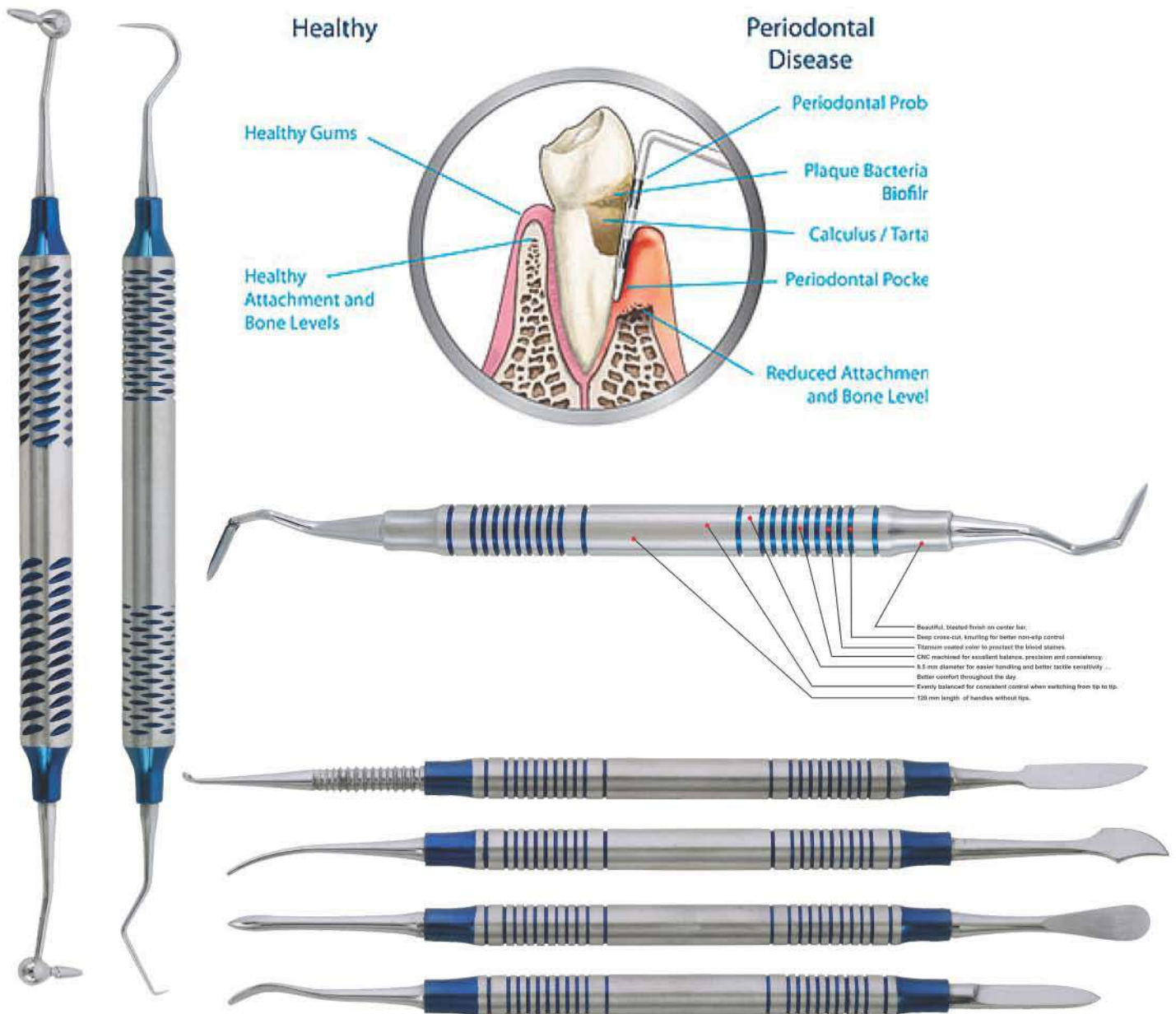

- High-polish mirror finish tips.
- Manufactured within the guidelines of the FDA quality assurance system for good manufacturing practices.
- Highest grade German stainless steel, razor sharp, durable tips. Rockwell hardened to 60 RHc.
- 27 of the most popular designs from graces to McCalls to columbias, and many european patterns.
- All instruments are guaranteed against defects in material and workmanship.

- All instruments bear the ce mark, emblematic of the european community's highest standards.
- Customer satisfaction guarantee, too!
- Less than 20 grams ... Lightweight for less hand fatigue.
- Manufactured to the most exacting standards so the 50th instrument you buy is exactly like your first.
- You decide ... Why pay more for the same high-quality instruments?

VALUED BUYERS

Compare our scalers and curettes with the best in the industry and you will immediately recognize we are equal in every way but one... price. Note the deep precision knurling for better tactile feel. The same high-grade stainless steel tips, the same light weight (under 20 grams) for less hand fatigue, the same professional craftsmanship, and surpassing the highest industry standards. Of course, any manufacturer can make these claims, but we guarantee and certify ours. We regularly manufacturing below articles in showing handles & pattern A to L for better grip & perfection. We are also fully equipped & capable to develop these instruments as per your own specific requirements & demands in materials, sizes, shapes and patterns.



A-Hollow Handle Ø 10 mm



B-Hollow Handle Ø 10 mm



C-Hollow Handle Ø 10 mm



D-Hollow Handle Ø 10 mm



E-Hollow Handle Ø 10 mm



F-Hollow Handle Ø 10 mm



G-Hollow Handle Ø 10 mm



H-Hollow Handle Ø 6.4 mm



I-Hollow Handle Ø 8 mm



J-Hollow Handle Ø 10 mm



K-Soild Handle Ø 6 mm



L-Soild Handle Ø 6 mm

MOUTH MIRRORS



- зеркал
- Espejos de la boca
- Mundspiegel
- дзеркал
- Miroirs à la bouche
- مرايا الفم

Plain



MD-600 Fig. 3 Ø20mm
MD-601 Fig. 4 Ø22mm
MD-602 Fig. 5 Ø24mm
MD-603 Fig. 6 Ø26mm



Cone-Socket Plain



MD-604 Fig. 3 Ø20mm
MD-605 Fig. 4 Ø22mm
MD-606 Fig. 5 Ø24mm

Magnifying



MD-607 Fig. 3 Ø20 mm
MD-608 Fig. 4 Ø22 mm
MD-609 Fig. 5 Ø24 mm



Cone-Socket Magnifying



MD-610 Fig. 3 Ø20mm
MD-611 Fig. 4 Ø22mm
MD-612 Fig. 5 Ø24mm

Rhodium



MD-613 Fig. 3 Ø20mm
MD-614 Fig. 4 Ø22mm
MD-615 Fig. 5 Ø24 mm



Cone-Socket Rhodium



MD-616 Fig. 3 Ø20mm
MD-617 Fig. 4 Ø22mm
MD-618 Fig. 5 Ø24mm

Front Surface



MD-619 Fig. 3 Ø20mm
MD-620 Fig. 4 Ø22mm
MD-621 Fig. 5 Ø24mm
MD-622 Fig. 6 Ø26mm



Cone-Socket Front Surface



MD-623 Fig. 3 Ø20mm
MD-624 Fig. 4 Ø22mm
MD-625 Fig. 5 Ø24mm

HANDLES FOR MOUTH MIRRORS

- Ручки для зеркал
- Manches pour miroirs à bouche
- Mundspiegelgriffe
- Ручки для дзеркал
- Mangos para espejos de boca
- مقابض لمرآيا الفم



MD-626
Hollow Mirror
Handle Round
Ø 10 mm



MD-627
Hollow Mirror
Hexagonal
Handle
Ø 8 mm



MD-628
Hollow
Ø 8 mm



MD-629
Hollow Mirror
Hexagonal
Handle
Ø 10 mm



MD-630
Hollow Mirror
Handle
Ø 8 mm



MD-631
Hollow Mirror
Handle
Ø 10 mm



MD-632
Mirror Handle
Solid
Ø 6 mm



MD-633
Mirror Handle
Solid
Ø 6 mm



MD-634
Mirror Handle
Solid Octagonal
Ø 6 mm



MD-635
Mirror Handle
Stem
with Rule
35mm



MD-636
Mirror Handle
Solid
Stem with
Rule 35mm



MD-637
Cone-Socket
Solid Octagonal
Ø 6 mm



MD-638
Cone-socket
Solid
Ø 6 mm



MD-639
Cone-socket
Hexagonal
Handle
Ø 6 mm

Cone-Socket Mirror Handle

EXPLORERS



- Зонды
 - Sondes
 - Zahnsonden
- Зонди
 - Sondas
 - المستكشفين

Examination kit Set of 3 Pieces



MD-640 Probe
MD-641 Mirror
MD-642 College Forcep
 15cm



Examination Set of 4 Pieces



MD-643 Exp,23/17-A
MD-644 Exavators
MD-645 Tweezers
MD-646 Mouth Mirror

MD-647

First Aid Examination Set of 3 Pieces



MD-648

First Aid Examination Set of 3 Pieces



MD-649

First Aid Examination Set of 3 Pieces



MD-650

First Aid Examination Set of 3 Pieces



- Пинцеты
 - Précelles - Brucelles
 - Zahnpinzetten
- Пінцети
 - Pinzas para algodón
 - ملاقط



MD-651
Surgical
11.5cm



MD-652
London College
15cm



MD-653
Semken Taylor
Str.



MD-654
Semken Taylor
Cvd.



MD-655
Meriam
16cm



MD-656
Dressing
14cm



MD-657
Semken Taylor
1x2 Straight



MD-658
Semken Taylor
1x2 Curved



MD-659
Gilles
15cm 1x2



MD-660
14cm 1x2



MD-661
Perry
13cm



MD-662
Atraumatic
15cm Cvd



MD-663
Atraumatic
15cm Str.



MD-664
College with Lock
15cm Cvd.



MD-665
Gerald
17.5cm



MD-666
with lock
15cm



MD-667
Atraumatic
17.5cm

TWEEZERS



- Пинцеты
- Précelles - Brucelles
- Zahnpinzetten

- Пинцети
- Pinzas para algodón
- ملاقط



MD-668
Adson-TC
12cm



MD-669
Adson-TC
12cm 1x2



MD-670
Adson-TC
15cm 1x2



MD-671
Adson
12cm



MD-672
Adson
12cm 1x2



MD-673
Adson
15cm 1x2



MD-674
Adson Brown
12cm



MD-675
Crane Kaplan
15cm



MD-676
Crane Kaplan
15cm



MD-677
Crane Kaplan
15cm



MD-678
Hemingway
15cm



MD-679
Miller
15cm Str.



MD-680
Miller
15cm Cvd.



MD-681
Dressing
Tweezer
14.5cm



MD-682
College
Curved
Tip 15cm



MD-683
Maryam
Tweezers
15cm



MD-684
College
Tweezer
15cm



MD-685
Perry
Tweezer
12.5cm



MD-686
Self-locking
Tweezer
15cm

- Зонды
- Sondes
- Zahnsonden
- Зонди
- Sondas
- المستكشفين

Single Ended Probe Solid Handle 4.5mm Length 150mm

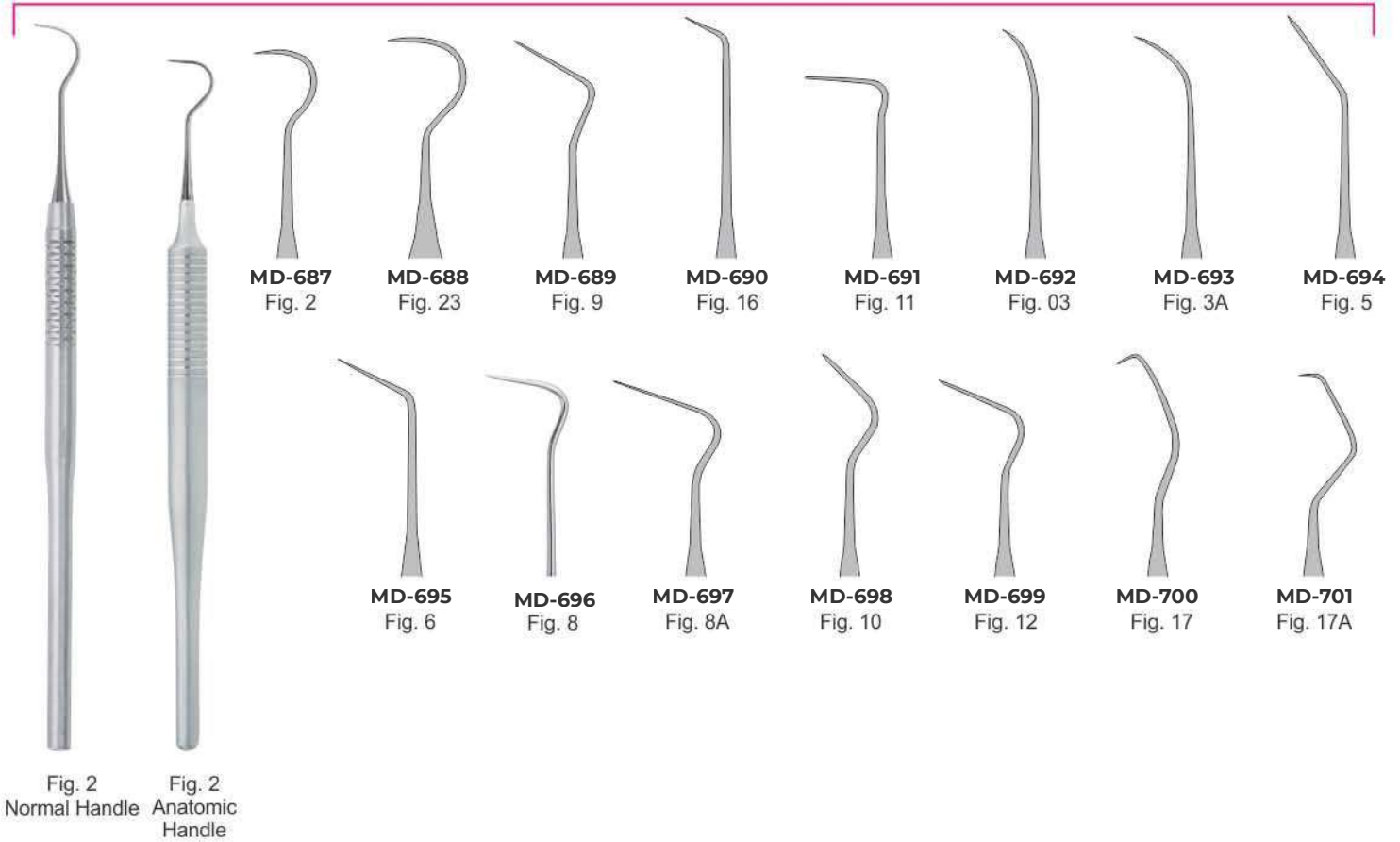

Explorers-Single-End

Double-Ended Explorers

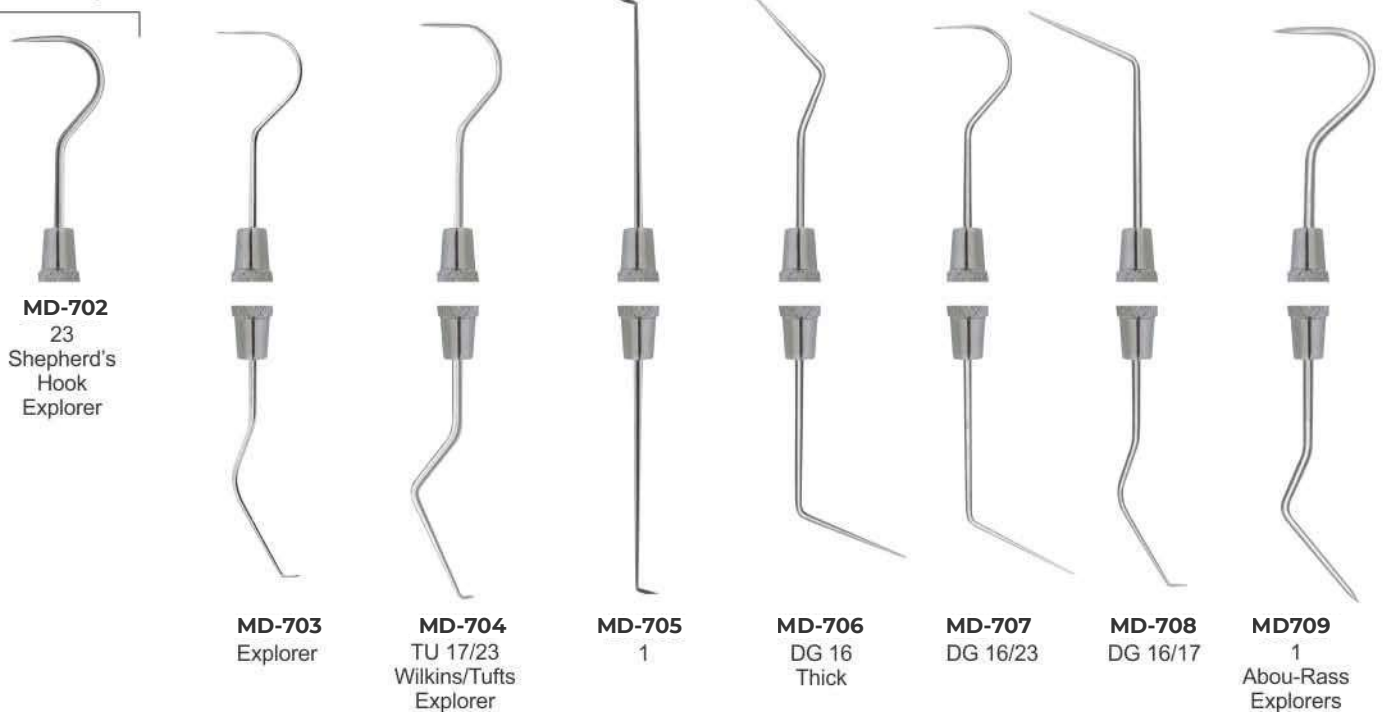

EXPLORERS



- Зонды
 - Sondes
 - Zahnsonden
- Зонди
 - Sondas
 - المستكشفين

Probes Double Ended 6mm, length 170mm



MD-710
Williams



MD-711
23/UNC1
university of north carolina Explorer



MD-712
Goldman Fox
Fig.17



MD-713
University of Michigan
Fig.17

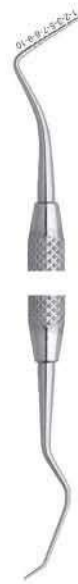

MD-714
Williams
Fig.17



MD-715
Goldman Fox
Fig.16



MD-716
University of Michigan
Fig.16



MD-717
Williams
Fig.16

Pointed Probes Double Ended Handle 6mm, length 170mm



MD-718
Goldman Fox
Williams



MD-719
Goldman Fox
Merrit B



MD-720
Goldman Fox
University of Michigan



MD-721
University of Michigan
Fig.23



MD-722
Williams
Fig.23



- Зонды
- Sondes
- Zahnsonden
- Зонди
- Sondas
- المستكشفين

EXPLORERS INSTRUMENTS SOLID HANDLE 6MM, LENGTH 170MM

PLUGGERS



<p>.50</p> <p>.75</p> <p>MD-724 5/7 21mm</p>	<p>1.00</p> <p>1.15</p> <p>MD-725 9/11 21mm</p>	<p>.50</p> <p>.60</p> <p>MD-726 1/2 Root Canal Plugger</p>	<p>.80</p> <p>1.10</p> <p>MD-727 3/4 Root Canal Plugger</p>
<p>.45</p> <p>MD-723 1/3 21mm</p>	<p>.20</p> <p>MD-728 MA57 27mm</p>	<p>.25</p> <p>MD-729 GP3 30mm</p>	
<p>.30</p> <p>MD-730 ISO Size 30 24mm</p>	<p>.40</p> <p>MD-731 ISO Size 40 24mm</p>	<p>.50</p> <p>MD-732 ISO Size 50 24mm</p>	<p>.60</p> <p>MD-733 ISO Size 60 24mm</p>

PERIODONTAL PROBES



- Зонды пародонтологические
- Sondas paradontales
- sonde parodontall
- зонди пародонтологічні
- Sondas paradontales
- المسابر اللثة

SPREADERS

HEAT CARRIERS

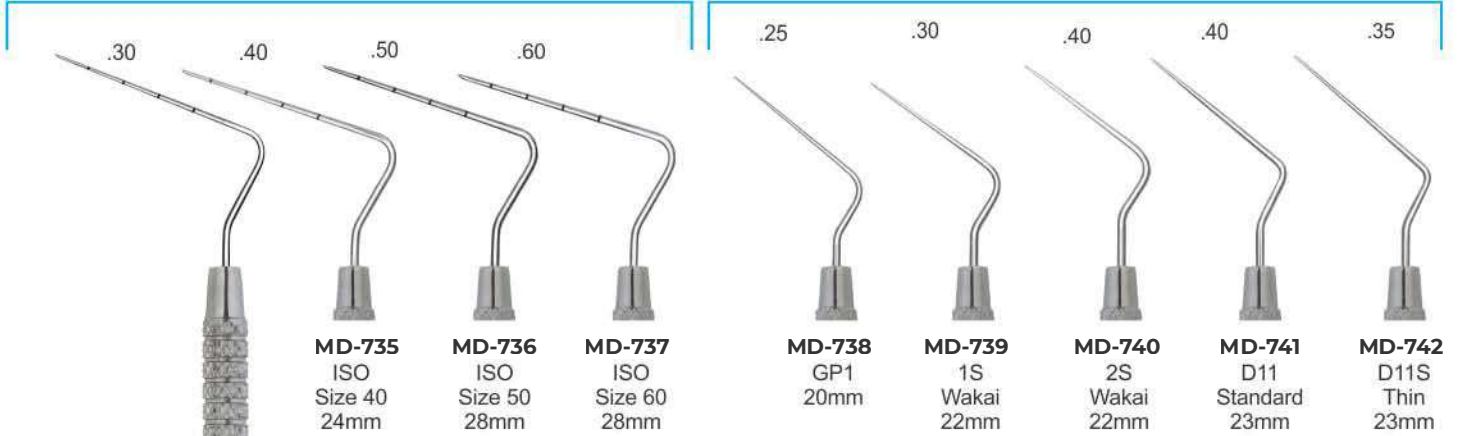

HEAT CARRIERS

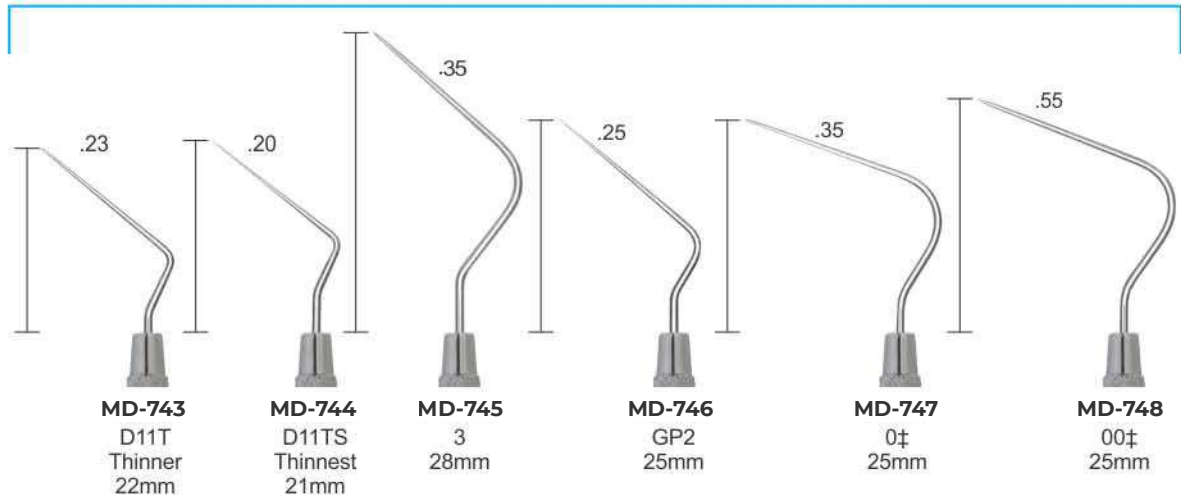

MD-734
ISO
Size 30
24mm

- Зонды пародонтологические
- Sondes parodontales
- sonda parodontali
- зонди пародонтологічні
- Sondas parodontales
- المسابر اللثة

ENDODONTICS INSTRUMENTS

ANTERIOR



MD-749
8A
29mm

MD-750
8 1/2A
29mm

MD-751
9A
29mm

MD-752
9 1/2A
29mm

MD-753
10A
29mm

MD-754
10 1/2A
29mm

MD-755
11A
29mm

MD-756
11 1/2A
29mm

MD-757
12A
29mm

LUKS



MD-758
L1
18mm

MD-759
L2
18mm

MD-760
L3
18mm

MD-761
L4
18mm



MD-762
Gracey Curettes 1/2

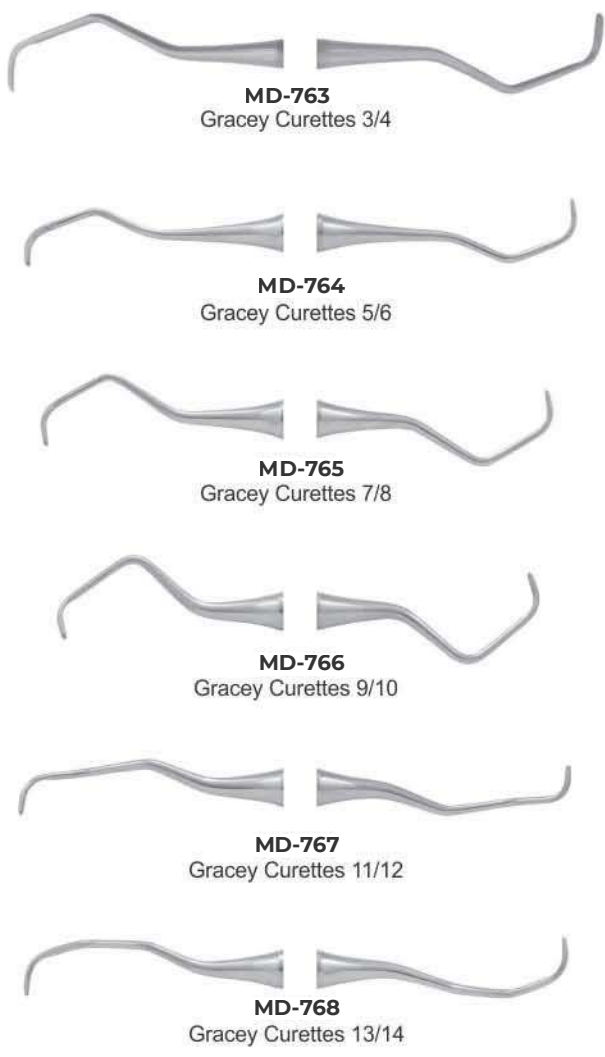

MD-769
Gracey Curettes 1/2

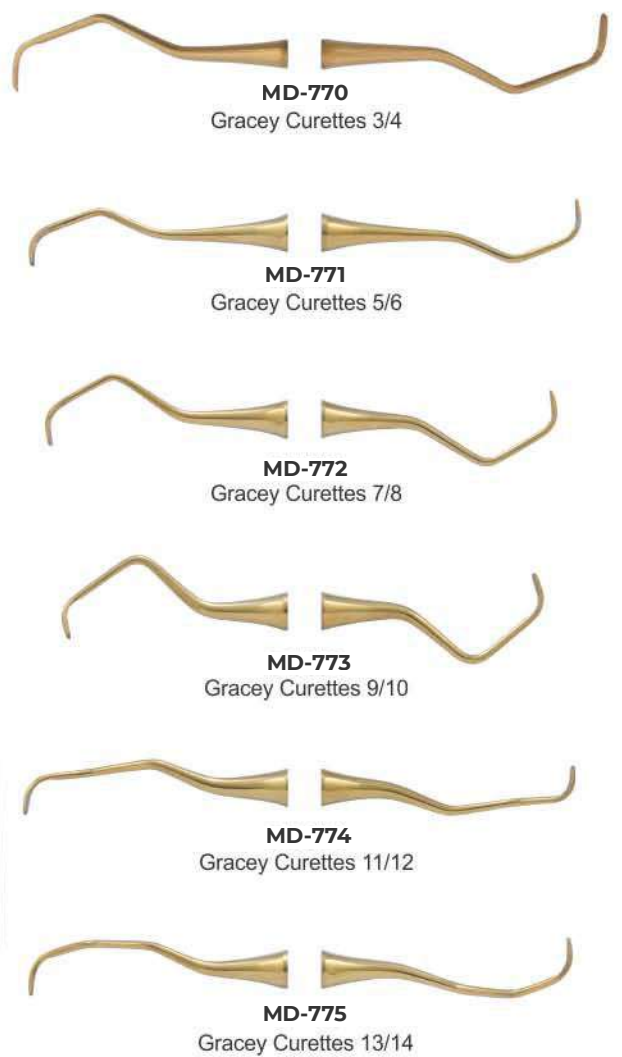

GRACEY MINI FIVE

Hollow Handle 9.5mm, Length 170mm Ceramic Coated Handle



MD-777
Fig. 3/4 Gracey 3M



MD-778
Fig. 5/6 Gracey 3M



MD-779
Fig. 7/8 Gracey 3M
Buccal and lingual/
Palatal surfaces



MD-780
Fig. 11/12 Gracey 3M
Mesial



MD-781
Fig. 13/14 Gracey 3M
Distal



MD-776
Fig. 1/2
Gracey 3m

GRACEY AFTER FIVE

Hollow Handle 9.5mm, Length 170mm Ceramic Coated Handle



MD-783
Gracey 3/4 AF



MD-784
Gracey 5/6 AF



MD-785
Gracey 7/8 AF



MD-786
Gracey 11/12 AF



MD-787
Gracey 13/14 AF



MD-782
Gracey
1/2 AF



Gracey Curettes



$\frac{3...1}{3...1} \mid \frac{1...3}{1...3}$ **MD-788** Fig. 1/2 GR - Gracey
Buccal surfaces



$\frac{5...1}{5...1} \mid \frac{1...5}{1...5}$ **MD-789** Fig. 3/4 GR - Gracey
Lingual/Palatal surfaces



$\frac{5...1}{5...1} \mid \frac{1...5}{1...5}$ **MD-790** Fig. 5/6 GR - Gracey



$\frac{8...4}{8...4} \mid \frac{4...8}{4...8}$ **MD-791** Fig. 7/8 GR - Gracey
Buccal and lingual/
palatal surfaces



$\frac{8...4}{8...4} \mid \frac{4...8}{4...8}$ **MD-792** Fig. 9/10 GR - Gracey
Buccal and lingual/
palatal surfaces more angled



$\frac{8...4}{8...4} \mid \frac{4...8}{4...8}$ **MD-793** Fig. 11/12 GR - Gracey
Mesial



$\frac{8...4}{8...4} \mid \frac{4...8}{4...8}$ **MD-794** Fig. 13/14 GR - Gracey
Distal



$\frac{8...4}{8...4} \mid \frac{4...8}{4...8}$ **MD-795** Fig. 15/16 GR - Gracey
Mesial



$\frac{8...4}{8...4} \mid \frac{4...8}{4...8}$ **MD-796** Fig. 17/18 GR - Gracey
Distal

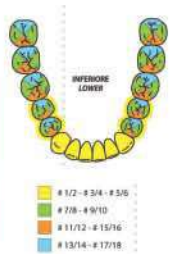
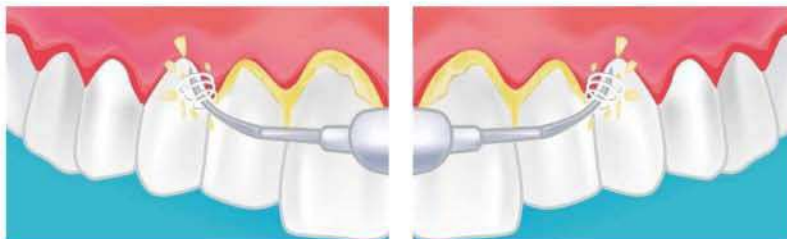
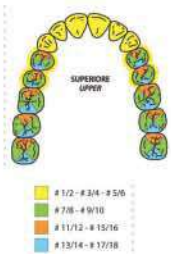

Sickle Scalars



MD-797 Fig. U15/33 - Towner-Jaquette



MD-798 Fig. U15/30 - Towner-Jaquette



MD-799 Fig. H5/33



MD-800 Fig. H6/H7



MD-801 Fig. 30/33 - Jaquette



MD-802 Fig. T2/T3 - Taylor



MD-803 Fig. 204



MD-804 Fig. 204S



MD-805 Fig. 11/12 - MC - McCall
Mesial



MD-806 Fig. 13/14 - MC - McCall
Distal

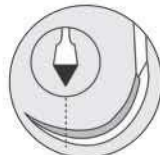
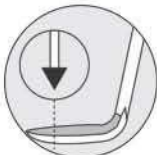

Straight and curved sickle scalars
Feature: 2 cutting edges curved facial component tipped ends

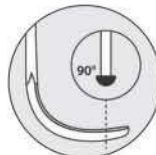

Universal curettes
are characterized by an angle of 90° between the terminal stem and the cutting component.

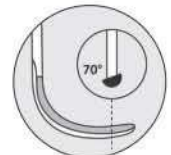

Gracey curettes
are characterized by an angle of 70° between the terminal stem and the cutting component.

Universal Curettes



MD-807 Fig. 13S/14S - MC - McCall



MD-808 Fig. 17S/18S - MC - McCall
Distal



MD-809 Fig. M23



MD-810 Fig. 204SD



MD-811 Fig. YG7/8-Younger Good



MD-812 Fig. L 1/2 - Langer



MD-813 Fig. L 3/4 - Langer



MD-814 Fig. L 5/6 - Langer



MD-815 Fig. M 23A



MD-816 Fig. M 23B

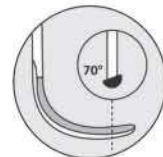
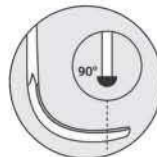
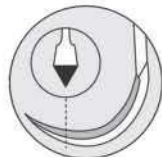
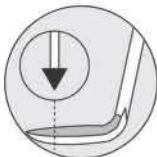

Straight and curved sickle scalers
Feature: 2 cutting edges curved facial component tipped ends

Universal curettes
are characterized by an angle of 90° between the terminal stem and the cutting component.

Gracey curettes
are characterized by an angle of 70° between the terminal stem and the cutting component.

Periodontal knives





MD-825
17



MD-826
17D



MD-827
54A
Mühlemann



MD-828
67



MD-829
37D



MD-830
8
Wiland



MD-831
8
Holz

0.9 mm



MD-832
9
Holz

0.7 mm

Chisels

Diamond coated margin trimmers

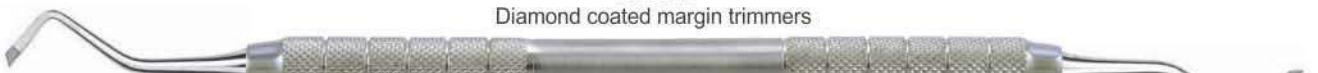

MD-833
40P



MD-834
40A

Thanks to the diamond-coated hand instruments the margins are evenly levelled.

Margin trimmers



MD-835
1TH2 Hirt



MD-836
5TH6 Hirt



MD-837
3TH4 Hirt



MD-838
7TH8 Hirt



MD-839
62NS61

2.0 MM



MD-840
37NS36

1.5 MM



MD-841
66NS65

1.0 MM



MD-842
79CI180 Black



MD-843
77CI178 Black



MD-844
279CI280 Black



MD-845
277CI278 Black



MD-846
179CI180 Black



MD-847
177CI178 Black

CHISELS



MD-848
1/2 Werdelstaedt



MD-849
3/4 Werdelstaedt



MD-850
7 Straight



MD-851
5/6 Straight



MD-852
7/10 Straight



MD-853
8/9 Binangle



MD-854
11/12 Binangle



MD-855
40/41 Binangle

Tartar Remover Instruments Solid Handle Ø 6 mm



MD-856
Fig. 1



MD-857
Fig. 1L
Left



MD-858
Fig. 1R
Right

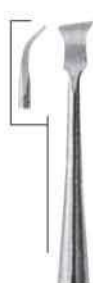

MD-859
Fig. 2L
left



MD-860
Fig. 2R
Right



MD-861



MD-862



MD-863



MD-864
WHITE 28



MD-865
WHITE 29



MD-866
WHITE 31



MD-867
WHITE 32



MD-868
WHITE 33



MD-869
WHITE 34



MD-870
WESTCOTT 21



MD-871
WESTCOTT 21B



MD-872



MD-873



MD-874
WHITE



MD-875
WHITE



MD-876



MD-877



MD-878



MD-879



MD-880



MD-881



MD-882



MD-883



MD-884



MD-885
PLANATOR



MD-886
PLANATOR



MD-887



MD-888



MD-889



MD-890



MD-891



MD-892



MD-893



MD-894



Ball Burnishers



MD-895



MD-896



MD-897



MD-898



Hatches



MD-899



MD-900



MD-901
Mini-Spatel



MD-902
Mini-Spatel

Spatulas rounded and sharp

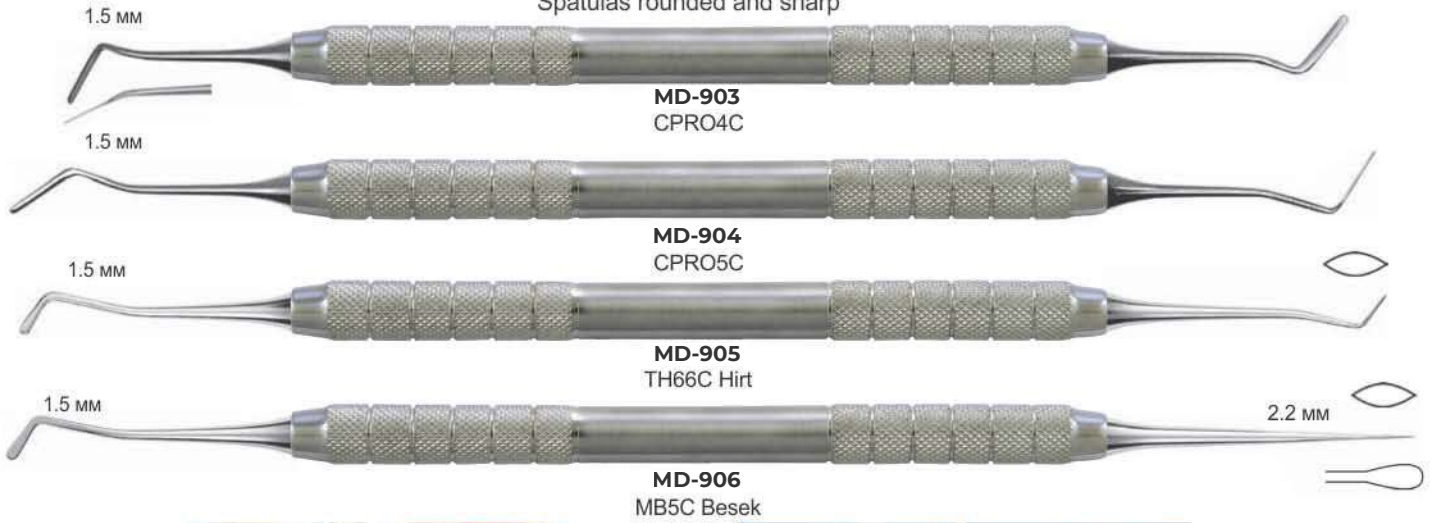

Spatulas Blade Thickness 0.22 mm

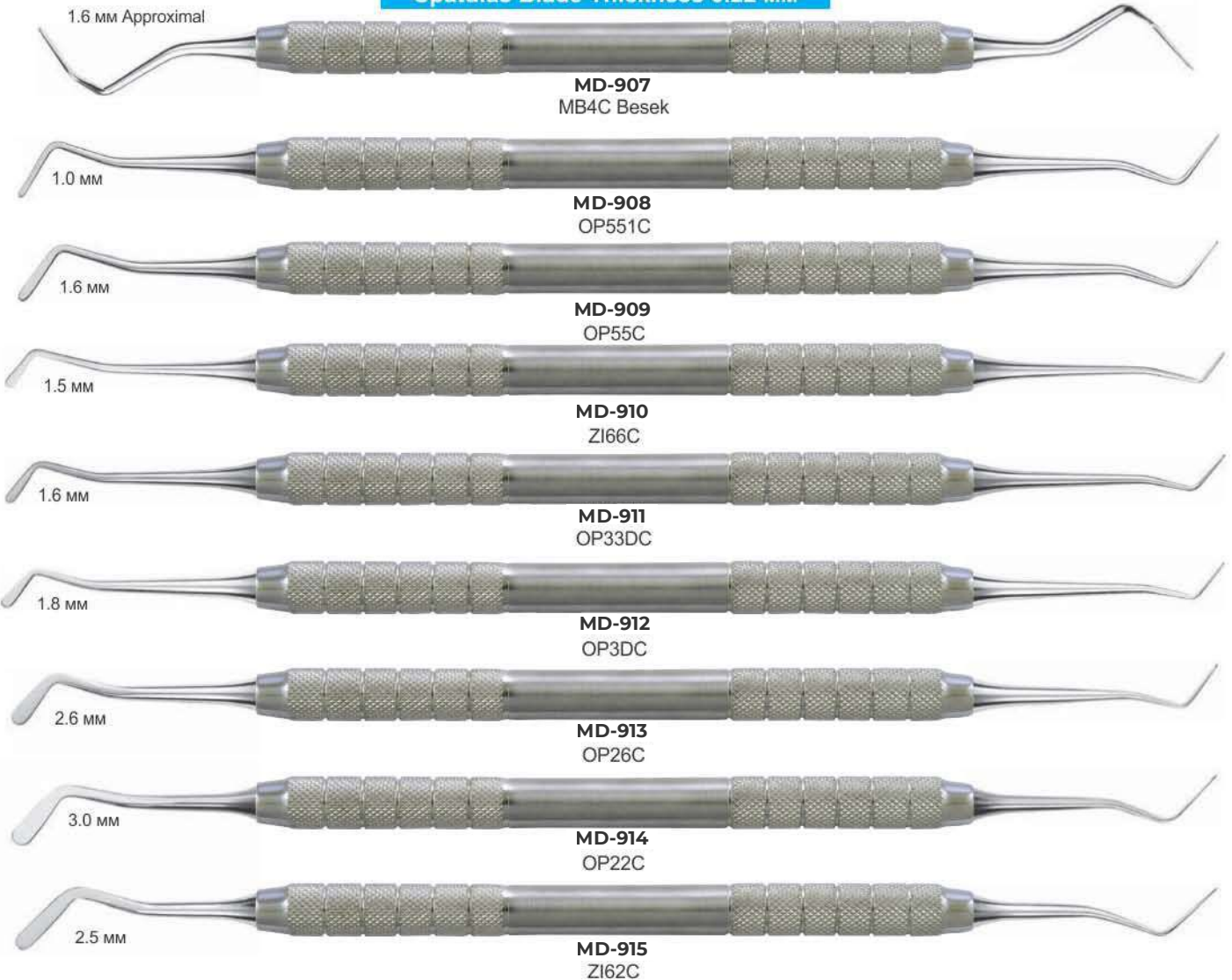

Spatulas

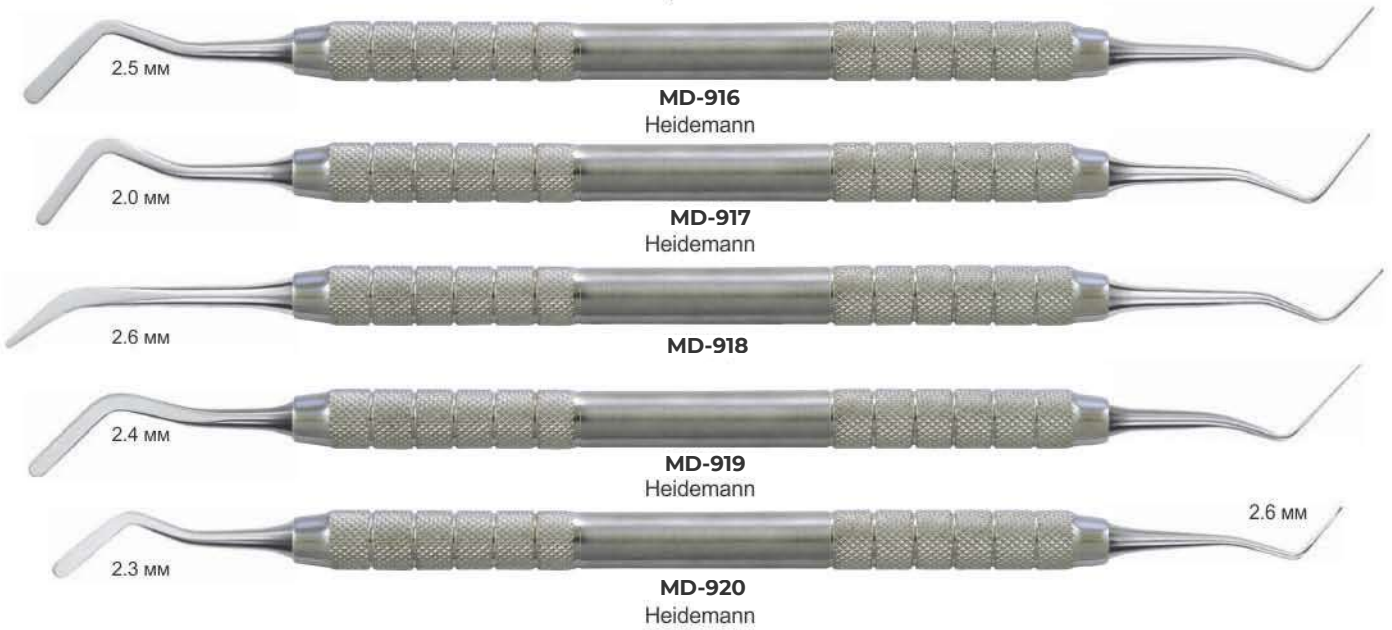

Spatulas-Pluggers



Water drop Our excavators have particularly sharp blades, free of burrs and perfectly rounded.



MD-929
0.8 MM



MD-930
0.8 MM



MD-931
0.8 MM



MD-932
1.1 MM



MD-933
1.1 MM



MD-934
1.2 MM



MD-935
1.2 MM



MD-936
1.4 MM



MD-937
1.6 MM



MD-938
1.9 MM





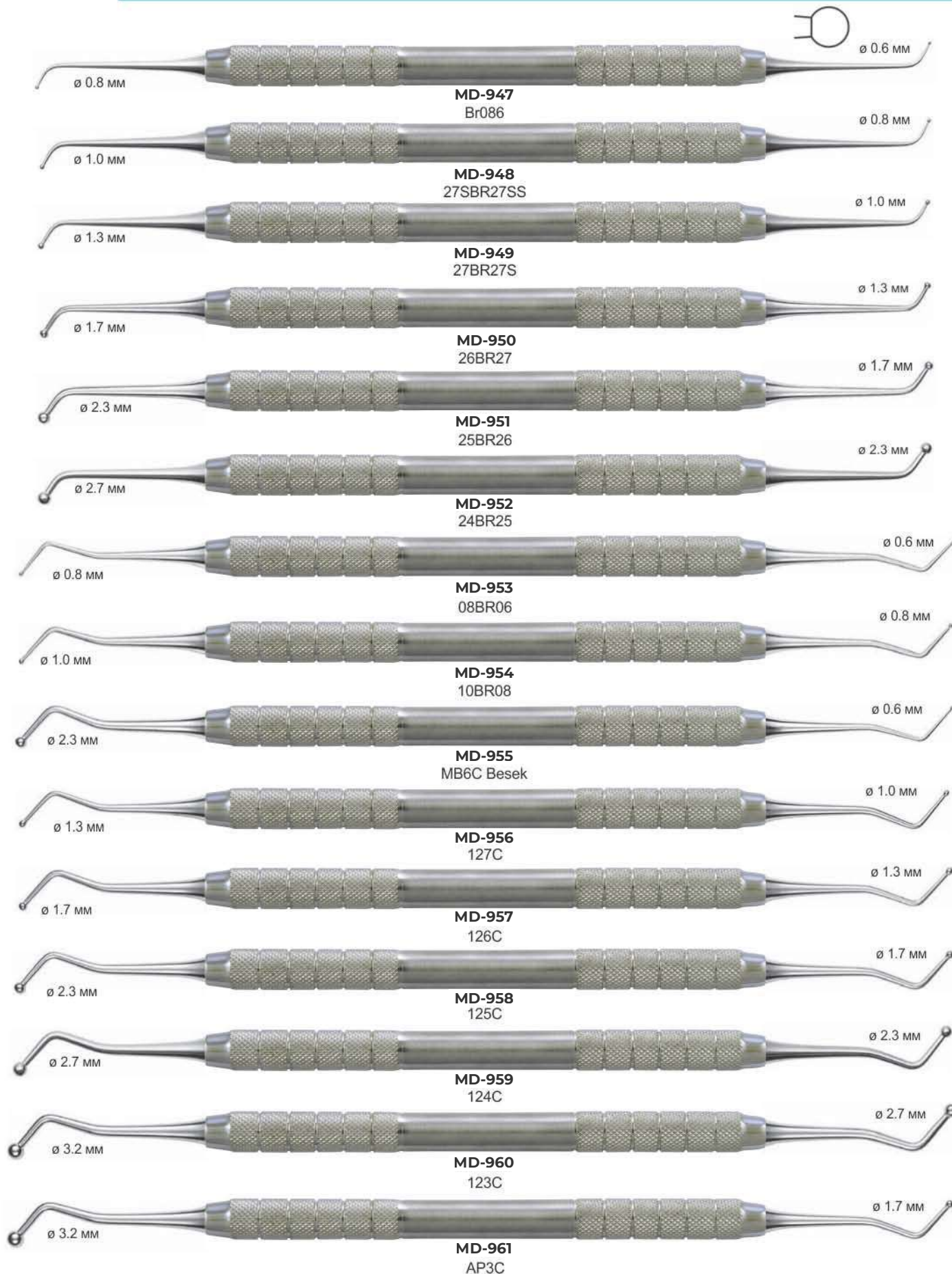

FILLING INSTRUMENTS CONSERVATIVE TREATMENT

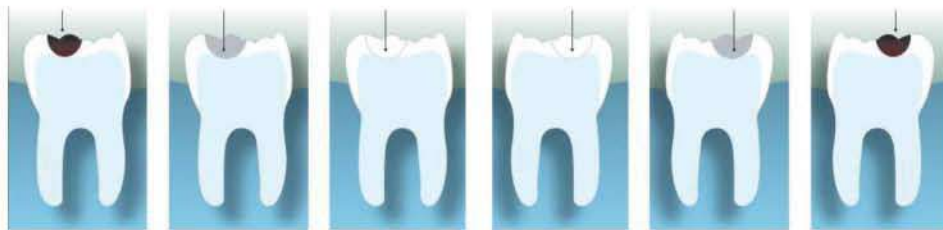

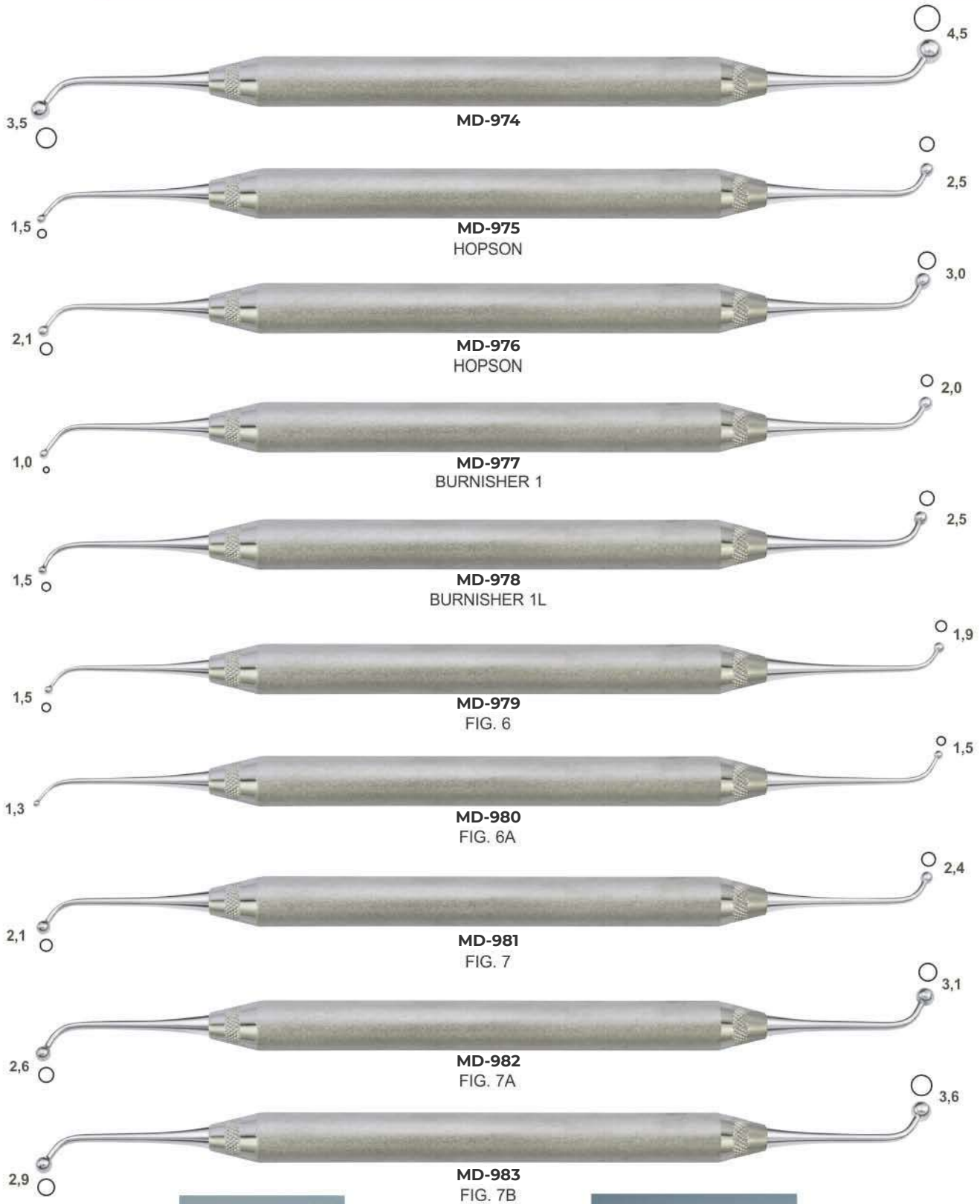

FILLING INSTRUMENTS CONSERVATIVE TREATMENT



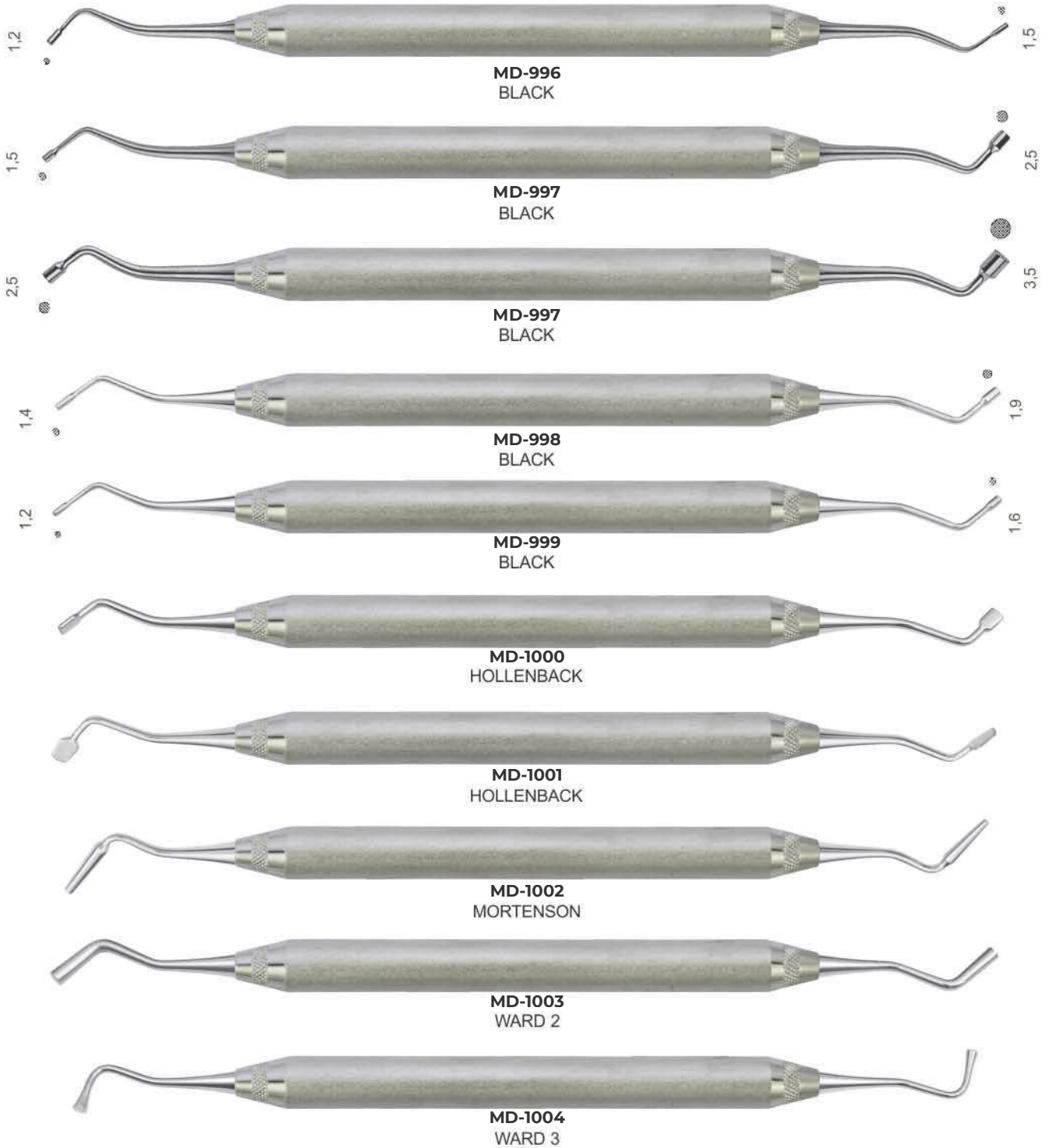



MD-1005
WILLIAMS



MD-1006
WILLIAMS



MD-1007
WILLIAMS



MD-1008



MD-1009



MD-1010



MD-1011



MD-1012



MD-1013



MD-1014

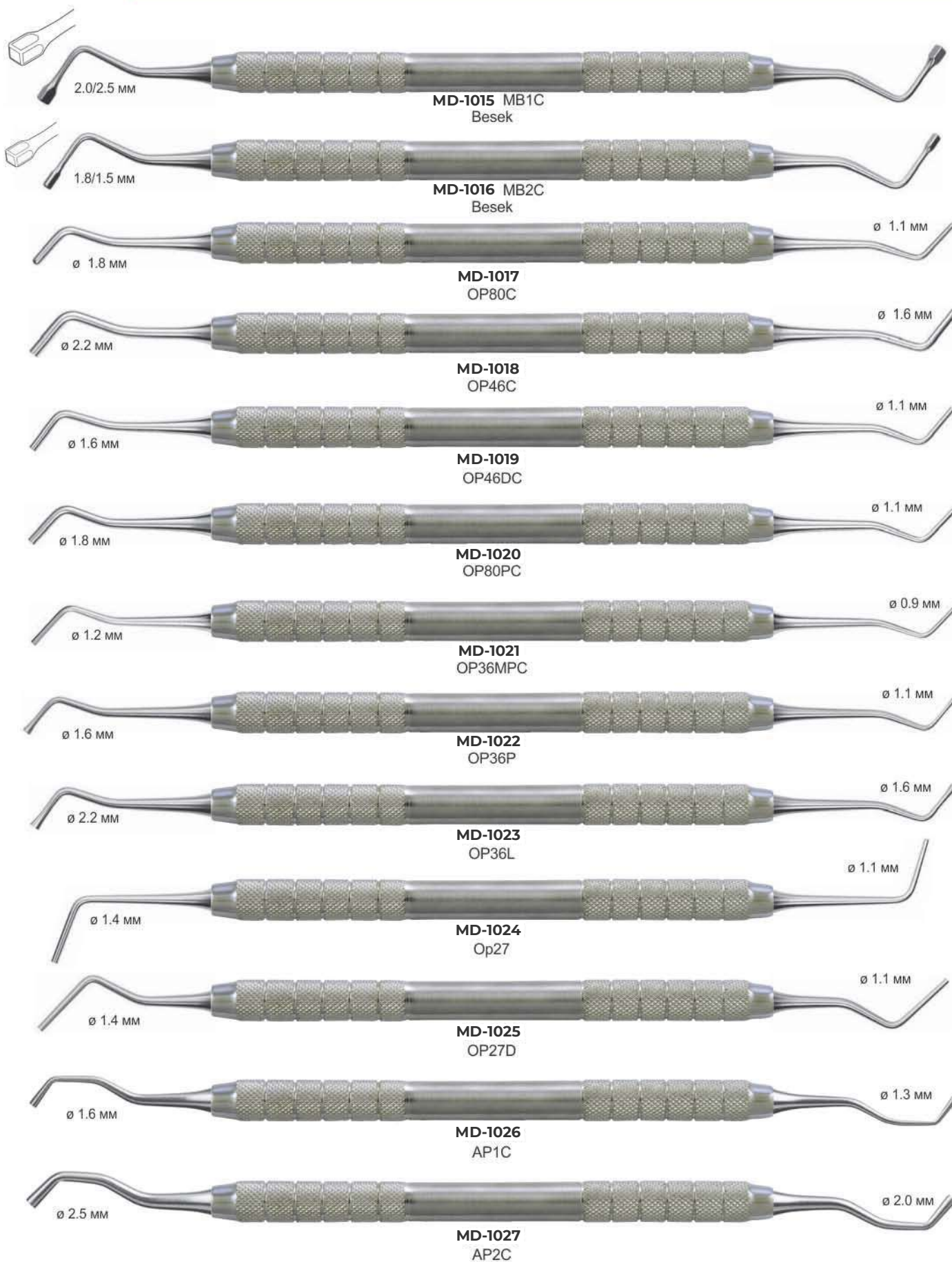

COMPOSITE PLUGGERS INSTRUMENTS

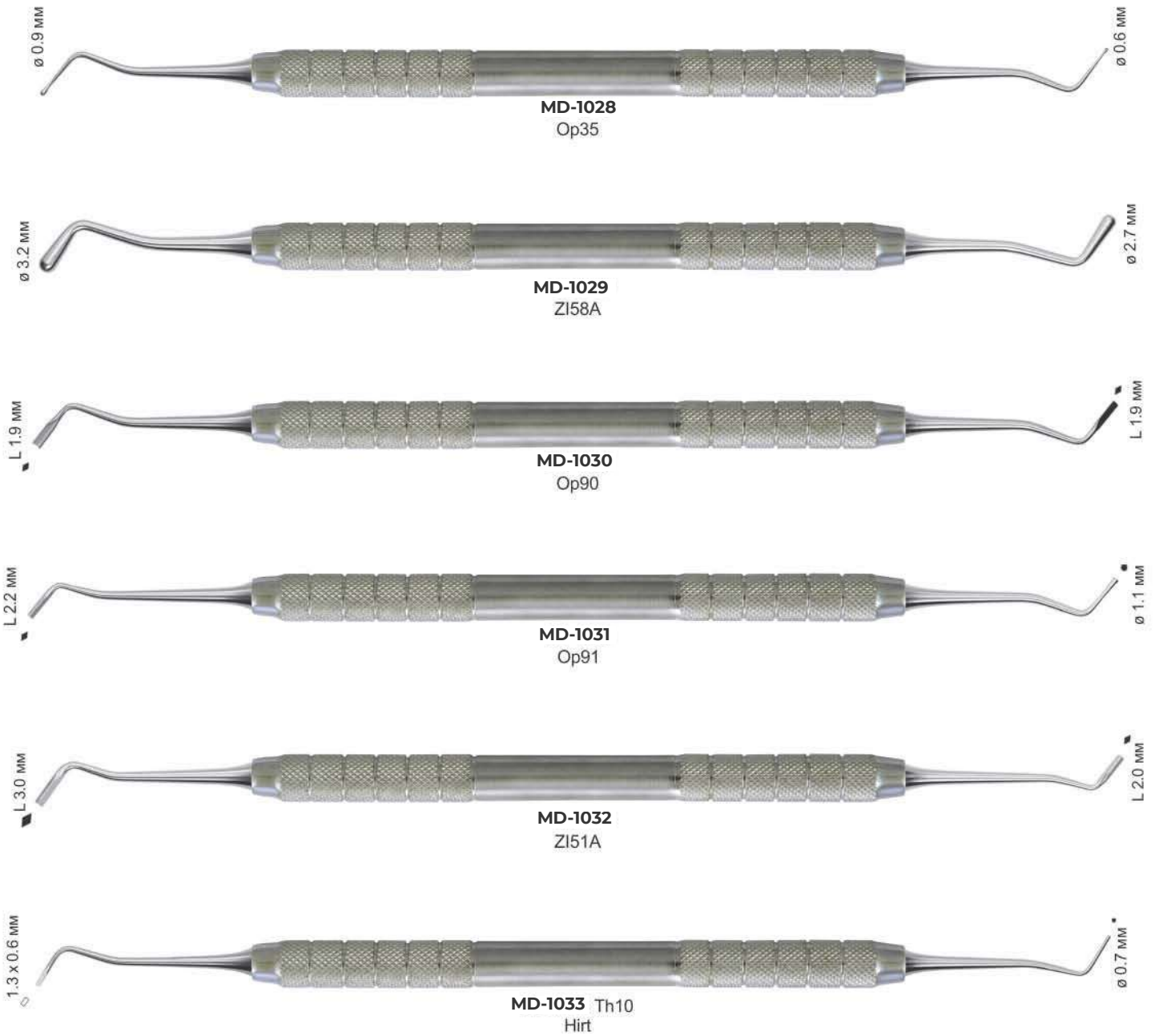

Serrated Pluggers



Instrument	Tip Diameter (mm)
MD-1034 OP36M	0.9
MD-1035 OP36D	1.1
MD-1036 Op36	1.6
MD-1037 Op52	1.0
MD-1038 Zi51	2.2
MD-1039 Op44	1.8
MD-1040 1BR2	1.7
MD-1041 2BR3	2.6





MD-1042 MF2C
Fuzzi



MD-1043
Pj4



MD-1044 MB3C
Besek



MD-1045
HZ3C



MD-1046
CPR03C



MD-1047 Mo1
Monari



MD-1048 TH28C
Hirt



MD-1049
HZ25C



MD-1050
Ck10



MD-1051
CK28BC



MD-1052 Op37
Carver



MD-1053
28BR29

Round excavators

- Cariology**
- for the removal of softened, carious dentin
 - for the removal of temporary fillings
- Surgery**
- to sever the periodontal ligament prior to extraction
 - for the removal of granulation tissue after extraction
- Design: Round working end Curved cutting edge



Round Excavator, 1.0 mm
MD-1054



Round Excavator, 1.5 mm
MD-1055



Round Excavator, 2.0 mm
MD-1056

Triple-angled back action excavators



Triple-angled Back Action Excavator, 1.0 mm
MD-1057



Triple-angled Back Action Excavator, 1.5 mm
MD-1058



Triple-angled Back Action Excavator, 2.0 mm
MD-1059



Triple-angled Back Action Excavator, 3.5 mm
MD-1060



FILLING INSTRUMENTS



- Инструменты для реставрации
- Instruments pour plombage
- Füllungsinstrumente (mit Kontrawinkel)
- Инструменти для реставрації
- Instrumentos para obturaciones
- ملء الصكوك

COMPOSITE/PLASTIC FILLING INSTRUMENTS SOLID HANDLE 6MM, LENGTH 170MM

BLACK

PLUGGERS/CONDENSERS

Hollenback

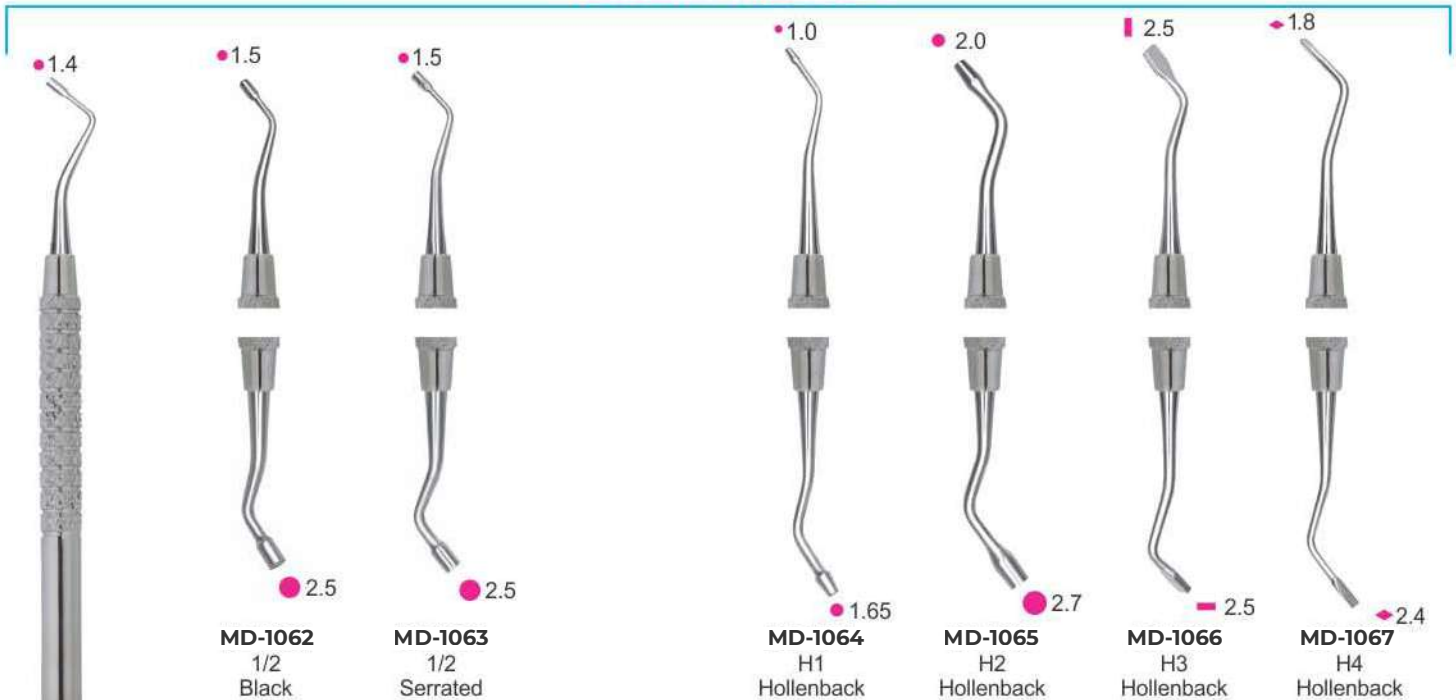

MARQUETTE CONDENSER

MORTONSON

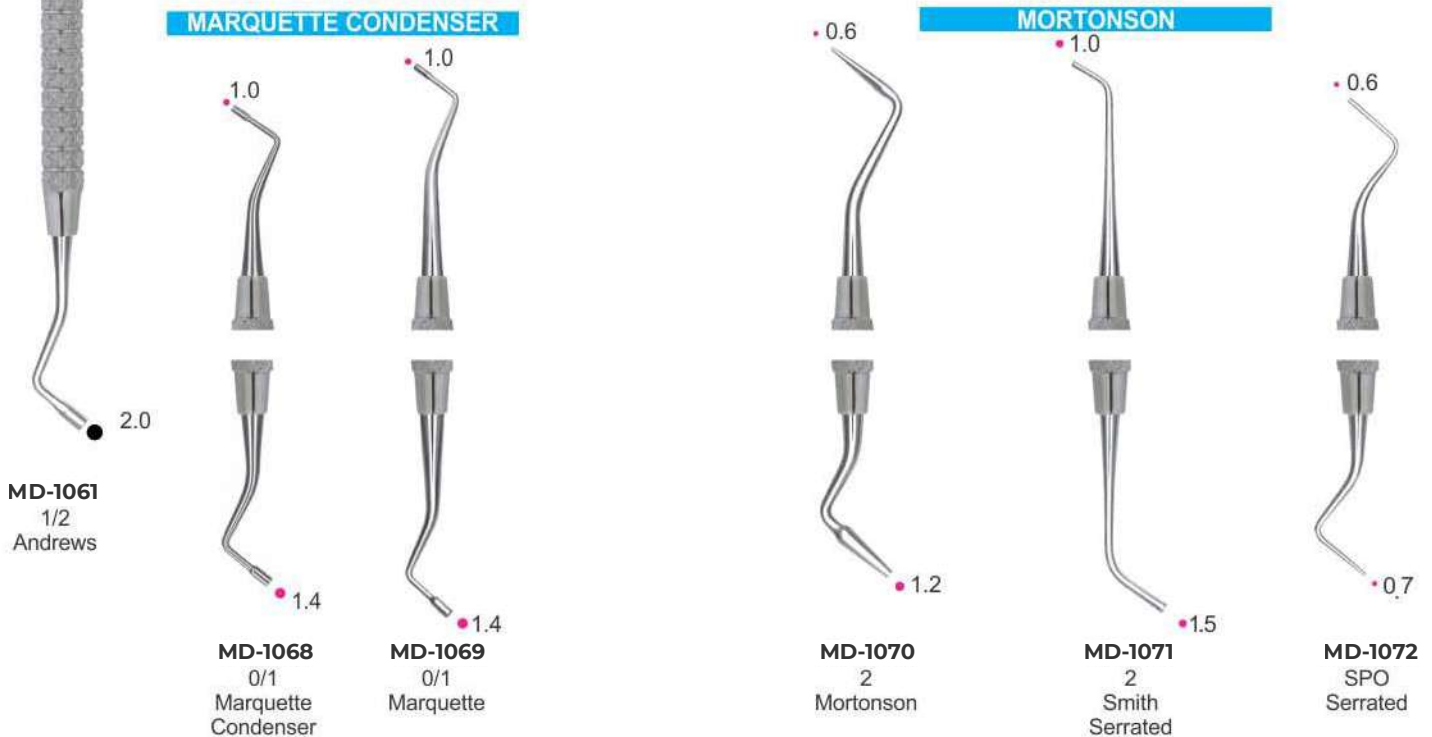

- Инструменты для реставрации
- Instruments pour plomage
- Füllungsinstrumente (mit Kontrawinkel)
- Инструменти для реставрації
- Instrumentos para obturaciones
- ملء الصكوك

RESTORATIVE INSTRUMENTS SOLID HANDLE 6MM, LENGTH 170MM Back Action Filling Instruments

Tanner Filling Instruments

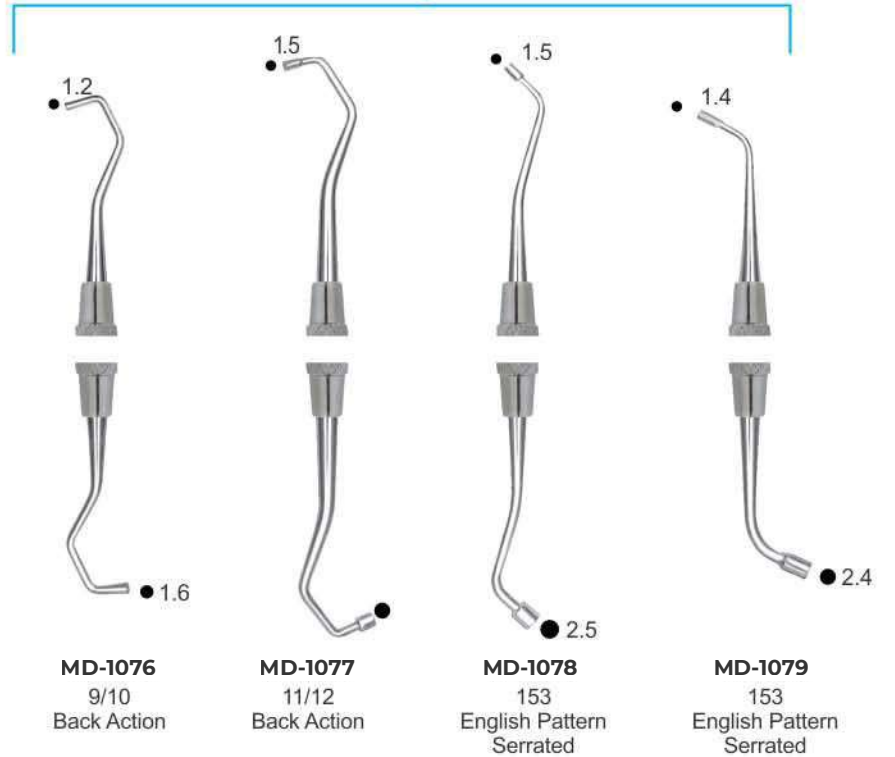

BALL



BURNISHERS

BEAVERTAIL



ACORN



LADMORE



CARVERS INSTRUMENTS



- Инструменты для реставрации
- Instruments a modeler
- Modellierinstrumente
- Инструменти для реставрації
- Instrumentos para modelar
- أدوات تقطيع

P.K. THOMS WAXING INSTRUMENTS SOLID HANDLE 6mm

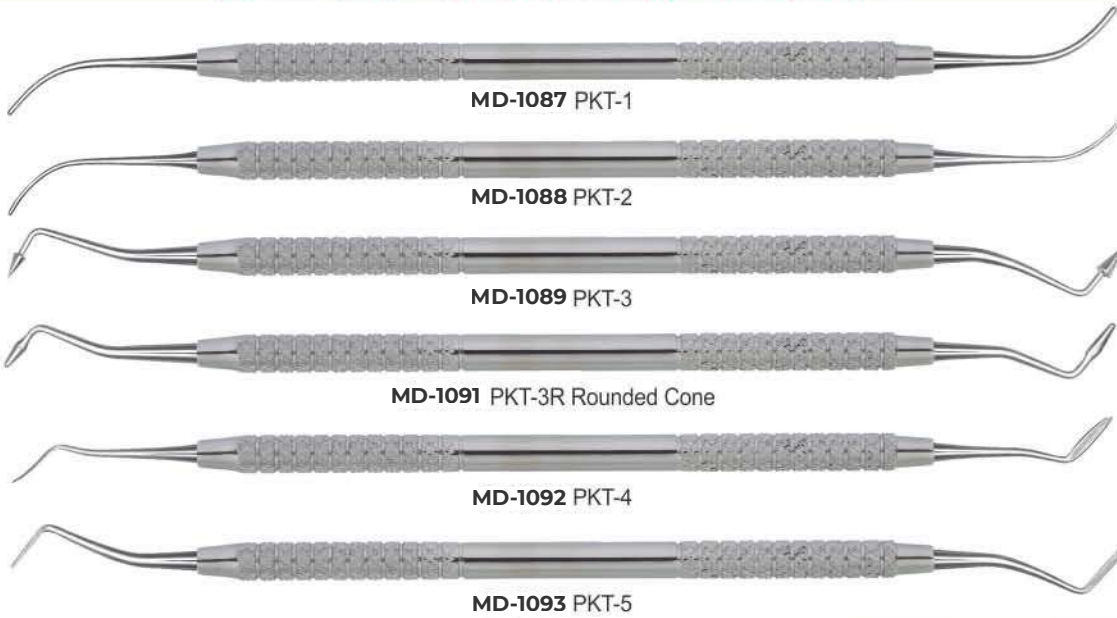

DE-1095
Composite Instruments Blue
Titanium with Cassettes



MD-1094
P.k. Thomas Waxing Instruments Kit

COMPOSITE INSTRUMENTS TITANIUM BLUE ENDODONTIC

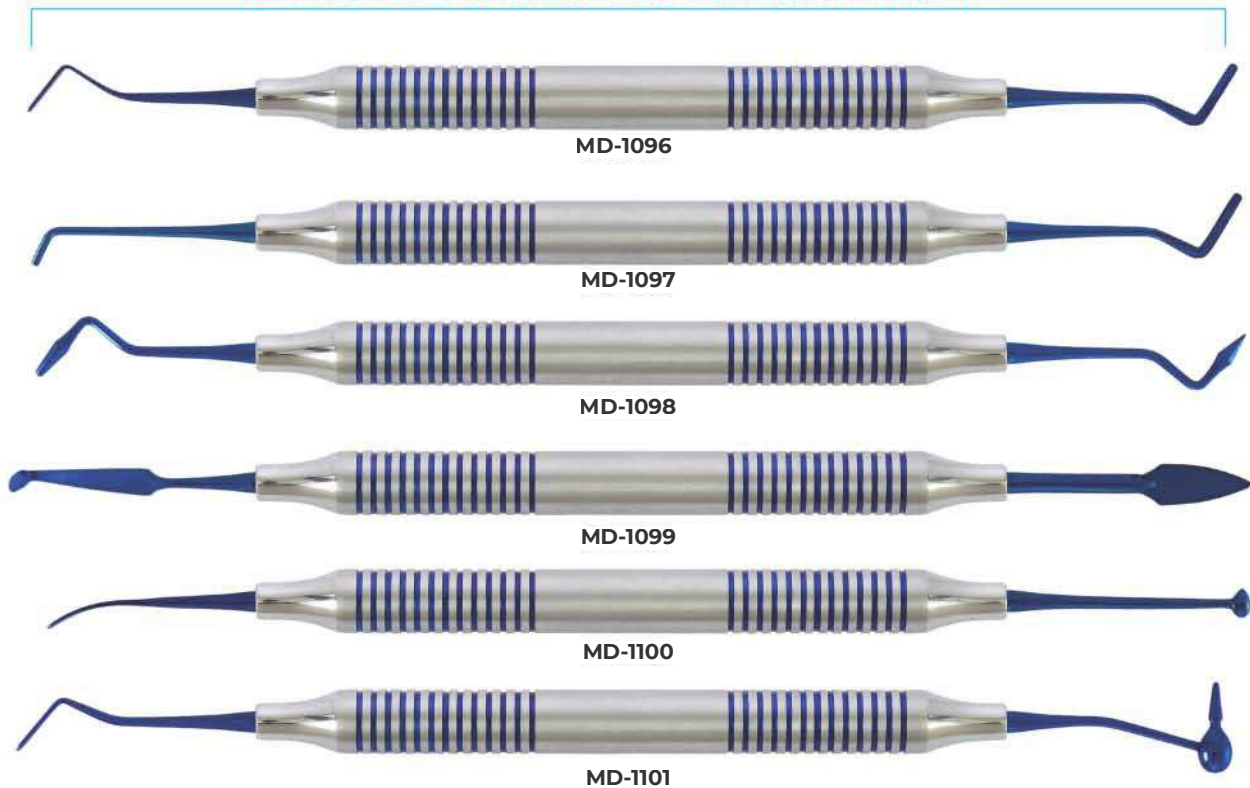

CARVERS INSTRUMENTS

- Инструменты для реставрации
- Instruments a modeler
- Modellierinstrumente
- Инструменти для реставрації
- Instrumentos para modelar
- أدوات تقطيع



MD-1102



MD-1103



MD-1104



MD-1105



MD-1106



Cassette For 5 Instruments
MD-1107

FILLING INSTRUMENTS



- Инструменты для реставрации
- Instruments pour plombage
- Füllungsinstrumente (mit Kontrawinkel)
- Инструменти для реставрації
- Instrumentos para obturaciones
- ملء الصكوك

FILLING INSTRUMENTS (Gold Pointed) SOLID HANDLE 6MM, LENGTH 170MM

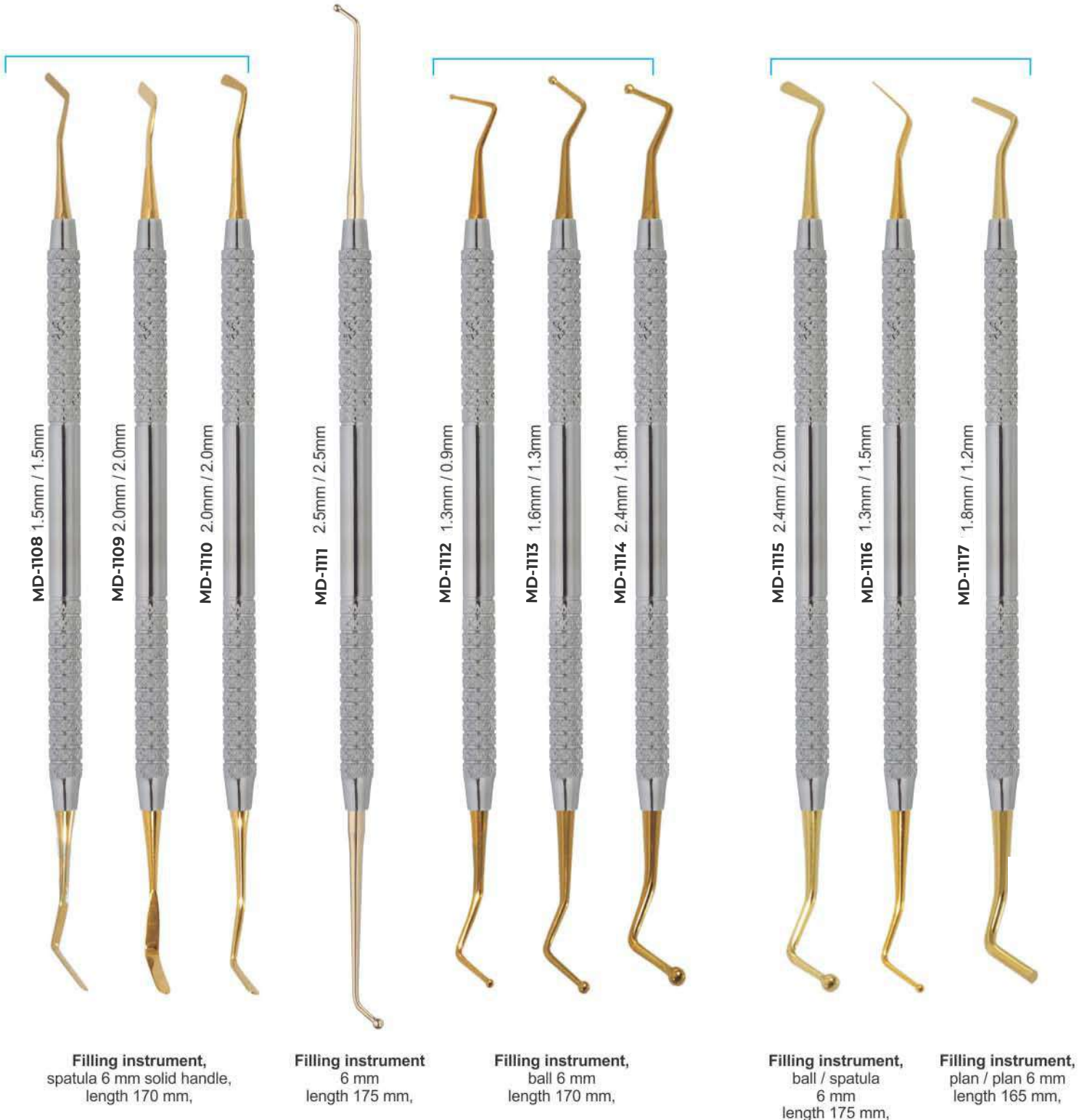

- Инструменты для реставрации
- Instruments pour plombage
- Füllungsinstrumente (mit Kontrawinkel)
- Інструменти для реставрації
- Instrumentos para obturaciones
- ملء الصكوك

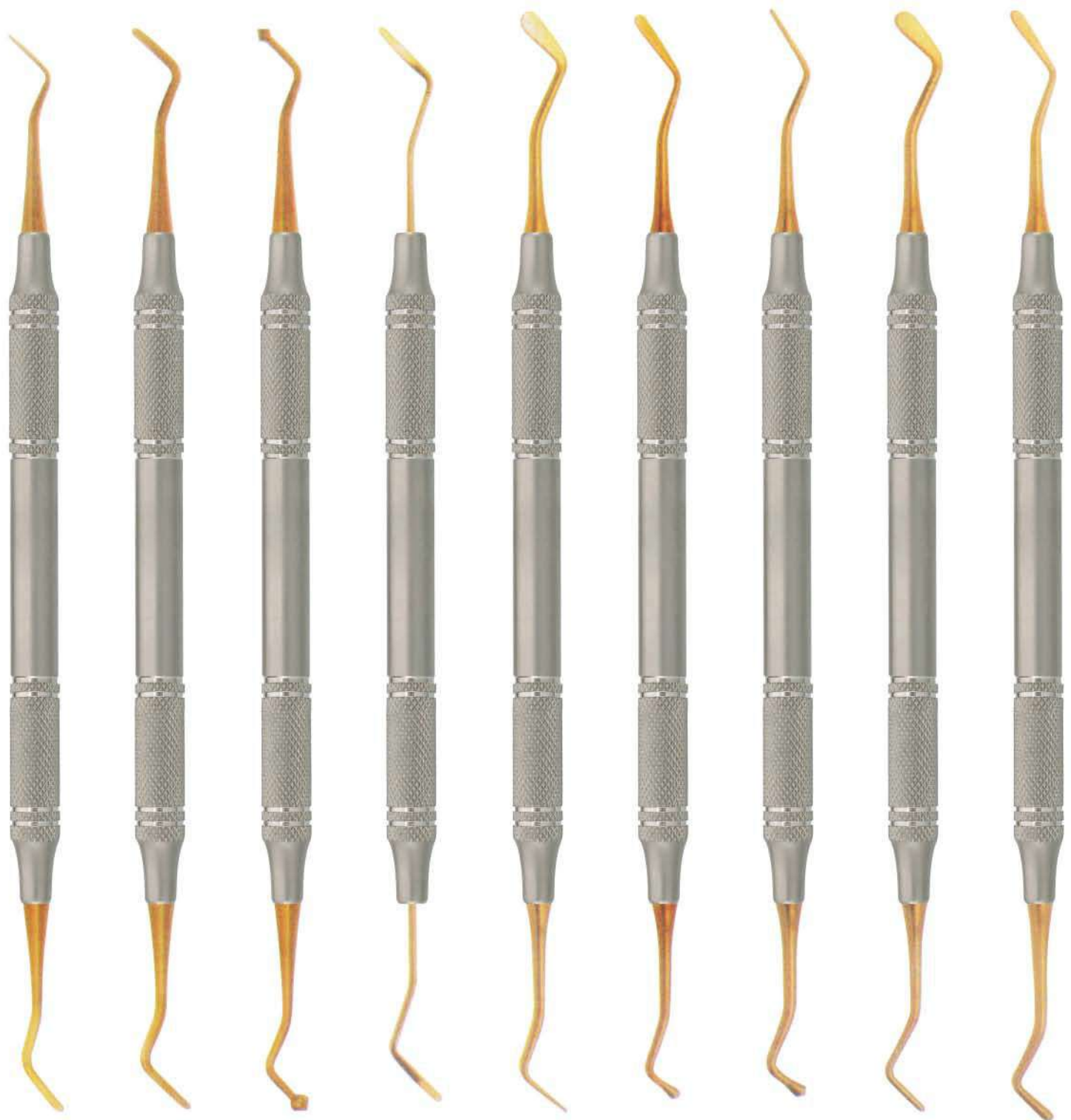

MD-1118

MD-1119

MD-1120

MD-1121

MD-1122

MD-1123

MD-1124

MD-1125

MD-1126

COMPOSITE FILLING INSTRUMENTS



- Инструменты для реставрации
- Instruments pour plombage
- Füllungsinstrumente (mit Kontrawinkel)
- Инструменти для реставрації
- Instrumentos para obturaciones
- ملء الصكوك

Composite Gold Tip Instruments



- Прочие товары
- Divers produits et services
- Sonstige Produkte
- Інші товари
- Varios Productos
- المنتجات المتنوعة



MD-1138
X Ray Film Hangers



MD-1139
X Ray Film Hangers



MD-1140
X Ray Film Hangers



MD-1141
X Ray Film Hangers



MD-1142
X Ray Film Hangers



MD-1143
X Ray Film Hangers



MD-1144
X Ray Film Hangers



MD-1145



MD-1146



MD-1147



Dissecting Set
MD-1148 Set of 9 Pcs.
MD-1149 Set of 11 Pcs.



MD-1150
Napkin Holder with Plastic Chain

MD-1151
Napkin holder with metal chain



Mouth Props
MD-1152
Small

Mouth Props
MD-1153
Medium

Mouth Props
MD-1154
Large

Key Rings



MD-1155



MD-1156



MD-1157



MD-1158



MD-1159



MD-1160

CEMENT SPATULAS



- Шпатели для цемента
- Spatules à ciment
- Zementspatel
- Шпатели для цементу
- Espátulas para cemento
- ملاعق الأسمنت

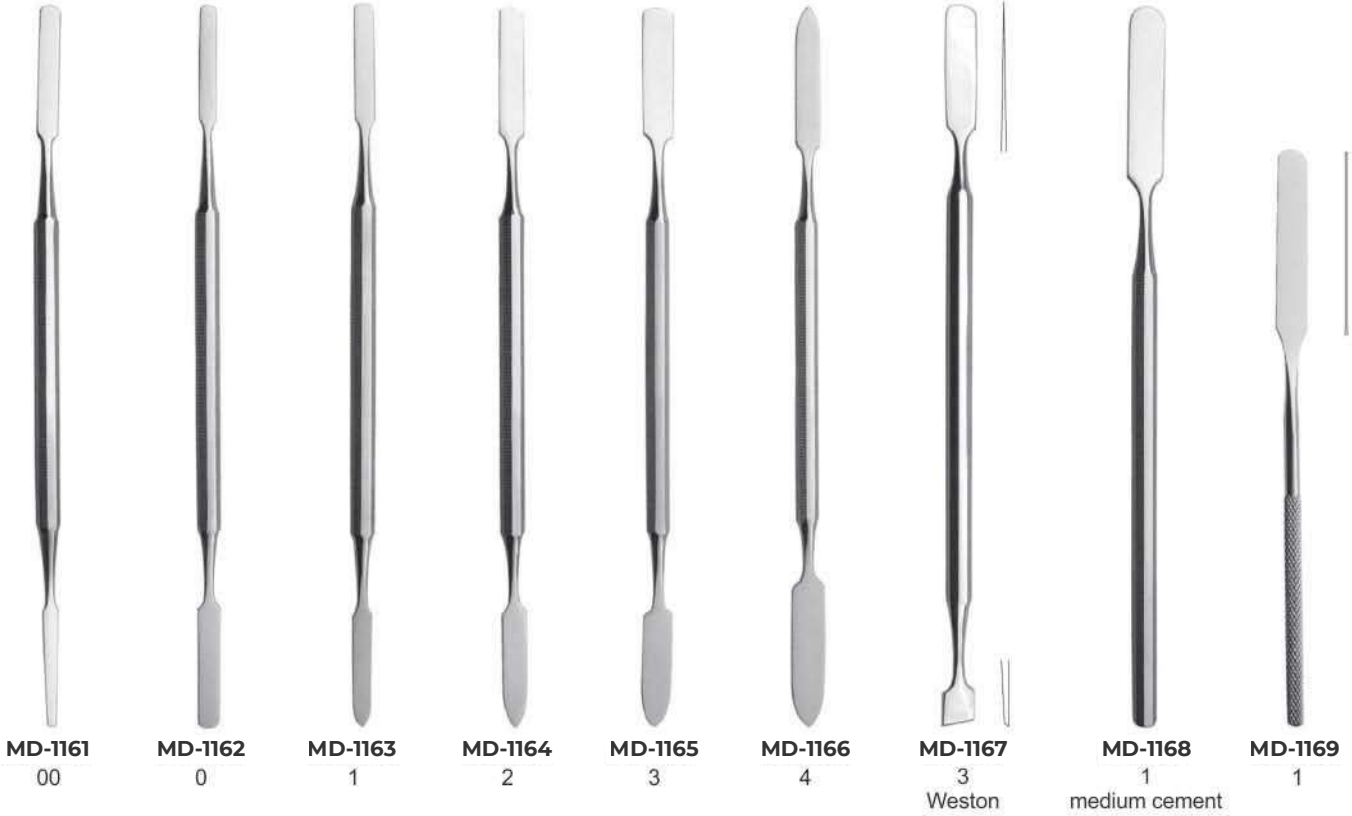

- Ножи для воска
 - Couteaux a cire
 - Wachsmesser
- Ножі для воску
 - Cuchillos para cera
 - السكاكين الشمع

ALGINATE, PLASTER SPATULAS, WAX KNIVES PLASTER FOR KNIVES & PLASTER SHEAR



MD-1183
Wooden Handle
Fig. 5
21.5 cm



MD-1184
Wooden Handle
Fig. 7
19.5 cm curved



MD-1185
Wooden Handle
Fig. 8
20 cm curved



MD-1186
Wooden Handle
Fig. 9
22.5 cm curved



MD-1187
Hook Knives



MD-1188
Fig. 1
Lessmann
12.5 cm



MD-1189
Fig. 2
Lessmann
17 cm



MD-1190
Fig. 1
with small spoon
12.5 cm



MD-1191
Fig. 2
with large spoon
17 cm



MD-1192
Bacolite Handle
Wax Knives,
Small



MD-1193
Bacolite Handle
Wax Knives,
Large



MD-1194
Wooden Handle
Wax Knives,
Small



MD-1195
Wooden Handle
Wax Knives,
Large



MD-1196
Plaster Knife



MD-1197
Fig. 1
17 cm



MD-1198
Fig. 3
16 cm



MD-1199
Fig. 4
16 cm



MD-1200
Special Inox
19.5 cm

ARTICULATORS



- Артикуляторы
 - Artocilar
 - Artikulations
- Артикулятори
 - Articuler
 - آرتیکولاتورس



MD-1201

Technical Datas:

Intercondylar distance	120 mm.
condylar inclination	fixed at 30°
Bennet angle	fixed at 7°
Incisal table inclination	10°
Distance between mounting plates	85 mm.
Weight	400 gr.
Opening (item 5000)	125°
Opening (item 5010)	180°



MD-1202

Technical Datas:

Intercondylar distance	110 mm.
condylar inclination	fixed at 30°
Bennet angle	fixed at 7°
Incisal table inclination	flat
Distance between mounting plates	85 mm.
Weight	450 gr.
Opening	180°



MD-1203

Stainless Steel Finishing

MD-1204

Royal Blue



MD-1205



MD-1206



MD-1207



MD-1208



MD-1209



MD-1210



MD-1211



MD-1212



MD-1213



MD-1214
Nakawalni
Dental Laboratory
Instrument

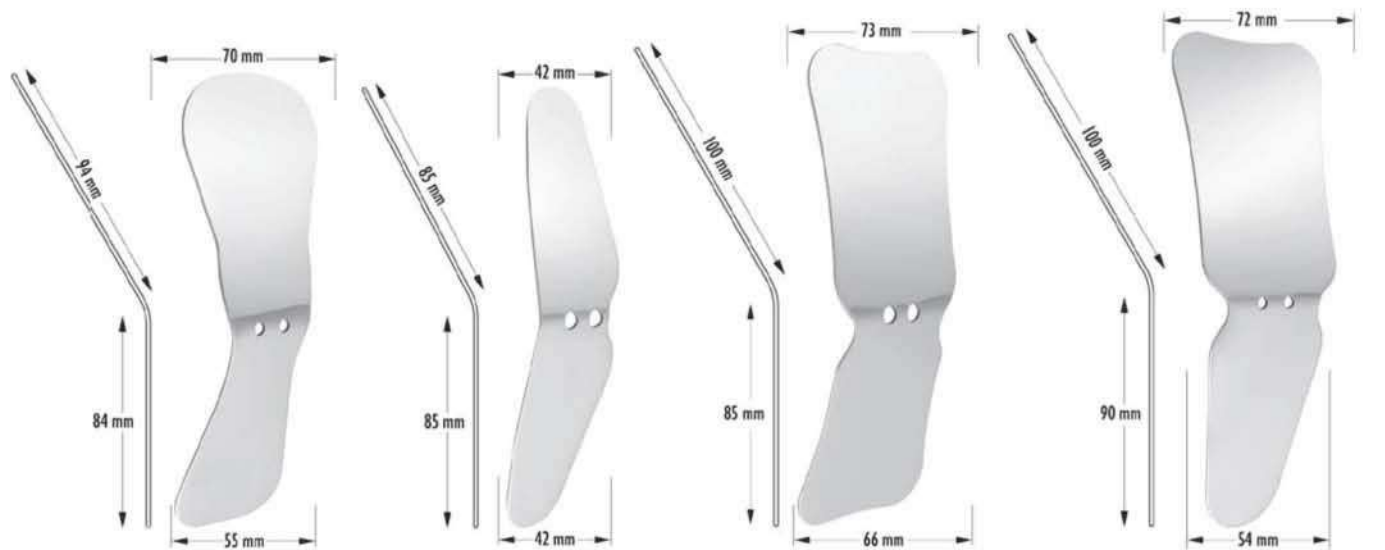

MD-1215 Adult Palatal /
MD-1216 Child Palatal

MD-1217
Buccal

MD-1218 Adult Palatal /
MD-1219 Child Palatal

MD-1220 Adult Palatal /
MD-1221 Adult Buccal

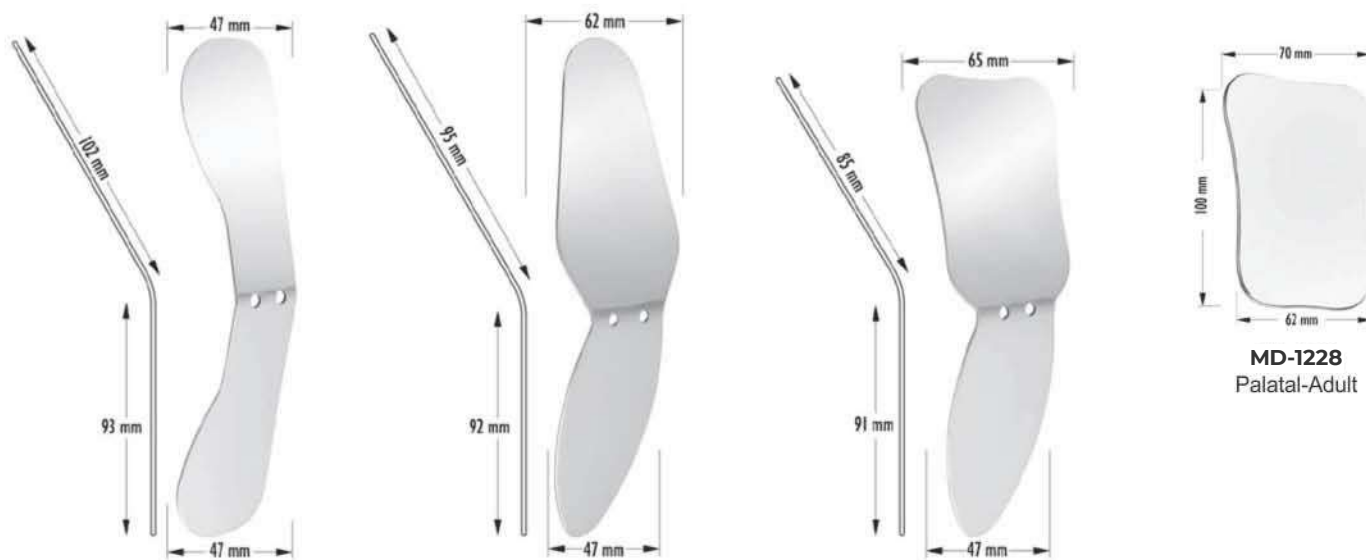

MD-1222 Lingual upper /
MD-1223 Lingual Lower

MD-1224 Adult Buccal /
MD-1225 Child Buccal

MD-1226 Child Palatal /
MD-1227 Child Buccal

MD-1228
Palatal-Adult

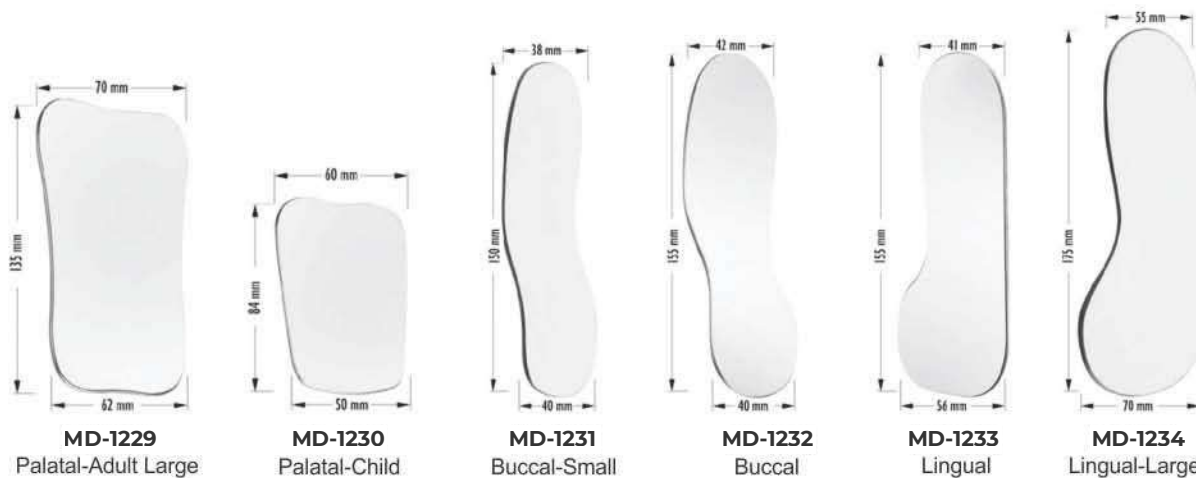

MD-1229
Palatal-Adult Large

MD-1230
Palatal-Child

MD-1231
Buccal-Small

MD-1232
Buccal

MD-1233
Lingual

MD-1234
Lingual-Large

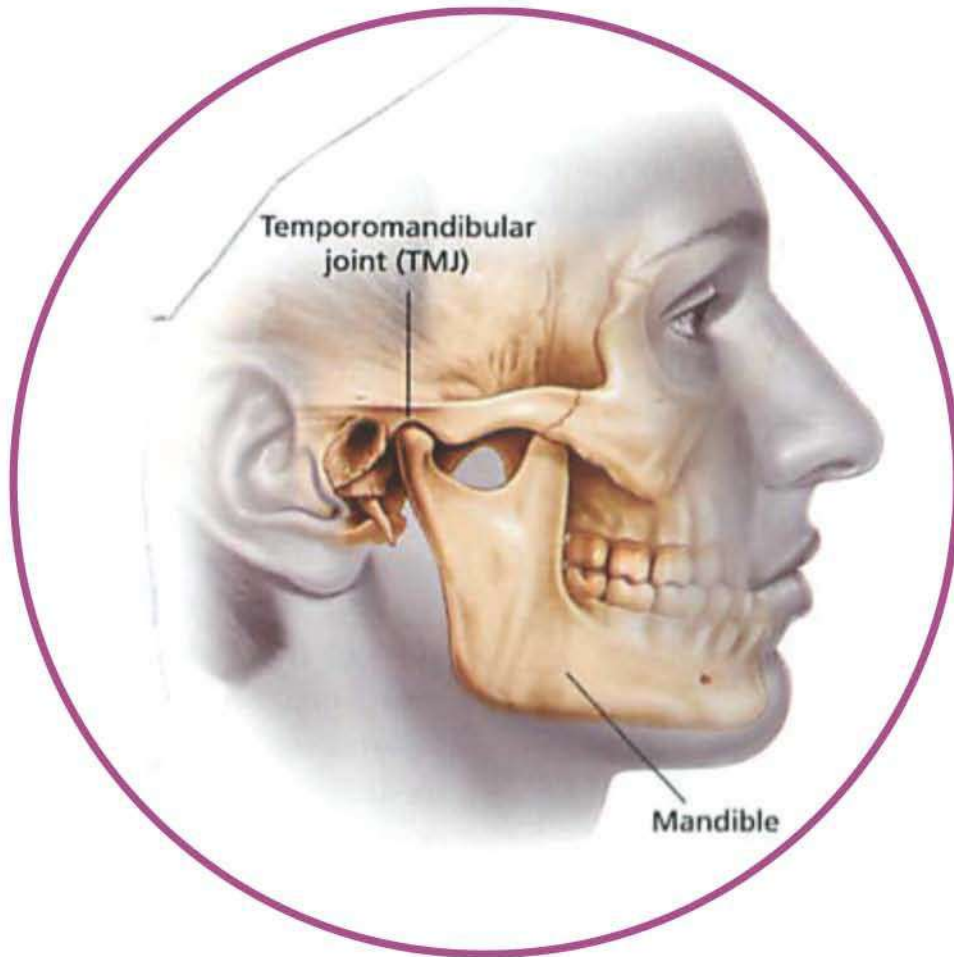

RETRACTORS - MOUTH GAGS

- Роторасширители
- Ecarteurs - Ouvre-bouches
- Vestibulumabhalter / Mundspanner
- Роторозширювачі
- Separadores - Abre-bocas
- الكاشطات - الكمامات الفم



MD-1251
HMG
Heister
130mm



MD-1252
Mouth Gag Molt
11 cm for (Children)



MD-1253
Mouth Gag Molt
14 cm for (Adults)



Sternberg Retractors
MD-1254 140 mm
MD-1255 180 mm



Columbia Retractor
MD-1256 140 mm



MD-1257
Wangen Holder
vestibule
15 cm, with or without
lip protection,



MD-1258
Wangen Holder
vestibule 15 cm, with
or without lip protection



MD-1259
Wangen Holder
with dual
function, 17 cm



MD-1260
140 mm



MD-1261
150 mm

Weider Retractor

RETRACTORS - MOUTH GAGS



- Роторасширители
- Ecarteurs - Ouvre-bouches
- Vestibulumabhalter / Mundspanner
- Роторозширювачі
- Separadores - Abre-bocas
- الكاشطات - الكمامات الفم



Weitlaner
Fig. 1
MD-1262 10.5cm
MD-1263 13.5cm



Weitlaner
Fig. 2
MD-1264 10.5cm
MD-1265 13.5cm



MD-1266
Lip & Cheek Retractor
Stainless Steel
Double Ended



MD-1267
Simplex Retractor
Stainless Steel
Single Ended



Weitlander
MD-1268 11cm
MD-1269 13cm
MD-1270 15cm



MD-1274
Denhard
12 cm



MD-1275
Roser-König
16 cm



MD-1276
Roser-König
19 cm



Jennings
MD-1271 11cm
MD-1272 13cm
MD-1273 15cm

- Ранорасширители
- Ecarteurs
- Wundhaken
- Ранорозширювачі
- Separadores
- الكاشحات

Wound, Bendable
Retractor, individually or as saving kit!



MD-1277
Cheek Retainer
One-sided
Long



MD-1278
Cheek Retainer
One-sided
Long



MD-1279
Cheek Retainer
One-sided
Long



**Ergo Grip
Retractor**
MD-1280 24 cm
ergonomic handle,



Ivory Retractors
Width adjustable
& fixable,
MD-1281 20 cm



Bruenings Retractors
tongue depressors
MD-1282 19 cm



**Minnesota
Retractors**
MD-1283 16 cm



Ribbon Retractors
MD-1284 20 cm
easy to bend
by hand,



Bishop Retractors
retractor and tongue
pushers Bishop with
comfortable margin
MD-1285 16 cm



**Combination
Retractors**
MD-1286 25 cm

RETRACTORS



- Ранорасширители
- Ecarteurs
- Wundhaken
- Ранорозширювачі
- Separadores
- الكاشحات



MD-1287
Unique Retractors
Length 175 mm
angled 45°



MD-1288
Unique Retractors
Length 175 mm
angled 90°



MD-1289
Retractors
16cm



MD-1290
Retractors
19cm



MD-1291
Mini-Langenbeck
Retractors
16 cm, hooks 22 mm



MD-1292
US Army Retractors
21 cm, 2



MD-1293
ALM Retractor
about 8 cm



MD-1294
Senn Mueller Retractor
17 cm, hooks 22 mm

- Ранорасширители
- Ecarteurs
- Wundhaken
- Ранорозширювачі
- Separadores
- الكاشحات



MD-1295
Langenbeck Retractors
surgical-flat
21 cm, hook
30x16 mm



MD-1296
Langenbeck Retractors
surgical-flat
21 cm, hook
42x11 mm



MD-1297
Langenbeck Retractors
surgical-flat
21 cm, hook
63x12 mm



Langenbeck Retractors
surgical-flat
21 cm, hook
MD-1298 30x16 mm
MD-1299 42x11 mm
MD-1300 63x12 mm



Langenbeck Retractors
21 cm, hook
MD-1301 30x11 mm
MD-1302 30x16 mm



MD-1303
Middelborpf
Retractors
21 cm

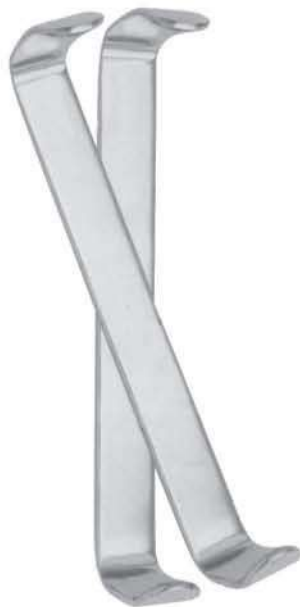

MD-1304
Farabeuf
(120 X 12mm
Set of 2 pices)



MD-1305
Retractor Seldin



MD-1306
Feldman Retractor
14cm

GUM SCISSORS



- Ножницы десневые
 - Ciseaux a gencives
 - Zahnfleischscheren
- Ножиці для ясен
 - Tijeras para encias
 - مقص صمغ



GUM SCISSORS

- Ножницы десневые
- Ciseaux a gencives
- Zahnfleissscheren
- Ножиці для ясен
- Tijeras para encias
- مقص صمغ



MD-1335
Iris
115mm
Angled



MD-1336
Iris
115mm
Curved



MD-1337
Goldman-Fox
130mm
Saw edge,
straight



MD-1338
Goldman-Fox
130mm
Saw edge,
curved



MD-1339
Goldman-Fox
130mm
Saw edge,
double curved

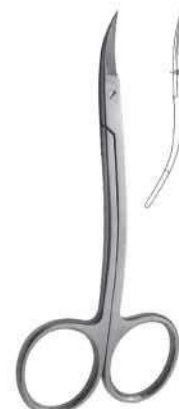

MD-1340
La Grange
115mm
Saw edge,
double curved



MD-1341
Neumann
120mm
Saw edge,
double curved



MD-1342
Kilner (Ragnell)
120mm
Straight



MD-1343
Kilner (Ragnell)
120mm
Curved



MD-1344
Joseph
140mm
Straight



MD-1345
Joseph
140mm
Curved



MD-1346
Kelly
160mm
Straight



MD-1347
Kelly
160mm
Curved



MD-1348
Locklin
160mm
Saw edge,
angular



MD-1349
Locklin
120mm
Saw edge,
angular



MD-1350
160mm
Saw edge, angular

MD-1351
Dean
170mm
Saw edge,
angular



MD-1352
Spencer
90mm



MD-1353
Spencer
130mm



MD-1354
Spencer
115mm



MD-1355
Noyes
110mm, Straight



MD-1356
Noyes
110mm
Curved



MD-1357
Noyes
110mm
Angular



MD-1358
Castroviejo
150mm
Curved

GUM SCISSORS

NEEDLE HOLDERS



- Ножницы десневые
- Ciseaux a gengivas
- Zahnfleischscheren

- Ножиці для ясен
- Tijeras para encias
- مقص صمغ

- Иглодержатели
- Porte-aiguilles
- Nadelhalter

- Голкотримачі
- Porta-agujas
- اصحاب ابرة



MD-1359
130mm
Straight



MD-1360 Mayo 130mm
MD-1361 Mayo 160mm
MD-1362 Mayo 180mm
Straight Curved

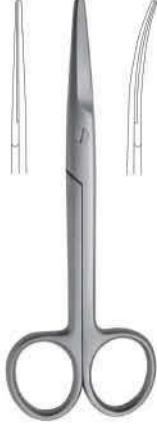

MD-1363 Mayo 140mm
MD-1364 Mayo 200mm
Straight Curved



MD-1365 Metzenbaum 145mm
MD-1366 Metzenbaum 200mm
Straight Curved



MD-1367
Beebee 110mm
Saw edge, straight



MD-1368
Beebee 110mm
Saw edge, curved



MD-1369
Beebe 110mm
Saw edge, straight



MD-1370
Beebe 110mm
Saw edge, curved



MD-1371
Universal 120mm
Saw edge



MD-1372
Universal 120mm



MD-1373 Rvder 130mm
MD-1374 Rvder 150mm
MD-1375 Rvder 180mm



MD-1376
Halsey 130mm



MD-1377
Baumgartner 130mm



MD-1378
Derf 120mm



MD-1379
Delicate 150mm



MD-1380 Mayo-Hegar 130mm
MD-1381 Mayo-Hegar 160mm
MD-1382 Mayo-Hegar 180mm
MD-1383 Mayo-Hegar 200mm



MD-1384
Crile-Wood 150mm
straight



MD-1385
Crile-Wood 150mm
curved

NEEDLE HOLDERS

- Иглодержатели
 - Porte-aiguilles
 - Nadelhalter
- Голкотримачи
 - Porta-agujas
 - اصحاب ابرة



Ryder
MD-1386 130mm
MD-1387 150mm
MD-1388 180mm



MD-1389
 Halsey
 130mm



MD-1390
 Baumgartner
 130mm



MD-1391
 Derf
 120mm



MD-1392
 Delicate
 150mm



MD-1393
 Adson
 170mm



Mayo-Hegar
MD-1394 130mm
MD-1395 160mm
MD-1396 180mm
MD-1397 200mm



MD-1398
 Crile-Wood
 150mm



Castroviejo
MD-1399 str 140mm cvd
MD-1400 str 180mm cvd



Olsen-Hegar Needle
 Holder With Scissors
MD-1401 140mm



Gillies Needle
 Holder With Scissors
MD-1402 160mm



Mathieu
MD-1403 140mm
MD-1404 170mm



Castroviejo
MD-1405 str 140mm cvd
MD-1406 str 180mm cvd



Olsen-Hegar Needle
 Holder With Scissors
MD-1407 140mm



Gillies Needle
 Holder With Scissors
MD-1408 160mm



Hartmann (Baby
 Mosquito)
MD-1409 90mm straight



Halstead Mosquito
MD-1411 125mm
 Straight

MD-1410
 125mm
 Curved

MD-1412
 Curved

GUM SCISSORS



- Ножницы десневые
- Ciseaux a gencives
- Zahnfleischscheren
- Ножці для ясен
- Tijeras para encias
- مقص صمغ



DE-1413
Goldman Fox Scissors
12.5cm Curved



MD-1414
Iris Scissors
11.5cm Curved
Serrated For Slip-Free Cutting



MD-1415
LaGrange Scissors
11.5cm Double Curved
Serrated For Slip-Free Cutting

Double
Curved



MD-1416
Castroviejo Micro Scissors
12cm Curved



MD-1417
Super Cut Goldman Fox
13.2cm Curved
Serrated For Slip-Free Cutting



MD-1418
Super Cut Iris
11cm Straight
Serrated For Slip-Free Cutting



MD-1419
Super Cut Iris
11cm Curved
Serrated For Slip-Free Cutting

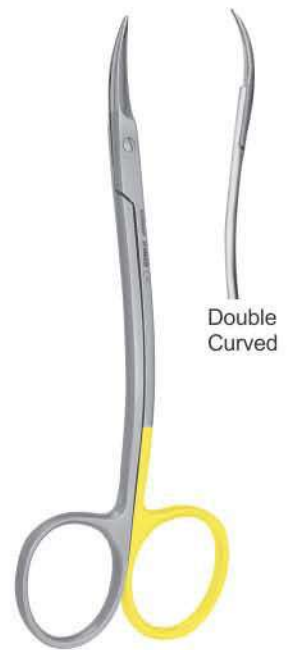

MD-1420
Super Cut LaGrange
11.5cm
Double Curved
Serrated For Slip-Free Cutting

Double
Curved

NEEDLE HOLDERS

- Иглодержатели
- Porte-aiguilles
- Nadelhalter
- Голкотримачи
- Porta-agujas
- اصحاب ابرة



MD-1421
Lichtenberg-
Ryder T.C
14 cm



MD-1422
Lichtenberg-
Ryder T.C
14 cm



MD-1423
Lichtenberg-
Ryder T.C
17 cm



MD-1424
Lichtenberg-
Ryder T.C
17 cm



MD-1425
Barraquer
18 cm



MD-1426
Barraquer
18 cm



MD-1427
Barraquer T.C
18 cm



MD-1428
Barraquer T.C
18 cm



MD-1429
Tönnis
18 cm



MD-1430
Castroviejo
13 cm
Straight



MD-1431
Kalt Needle Holders T.C
14 cm Straight



MD-1432
Peet Splinter Forceps
11.5 cm

MD-1433
La Grange
Curved



MD-1434
All-Purpose Pliers

HAEMOSTATIC FORCEPS & TOWEL CLAMPS



- Зажимы артериальные, зажимы для салфеток
- Pincers hemostatiques, Pincers a compresses
- Arterienklemmen, Tuschklemmen
- Затискачі артеріальні, затискачі для серветок
- Pinzas hemostaticas, Pincers para compressas
- الملقط هایموستاتیک المشابک منشفه

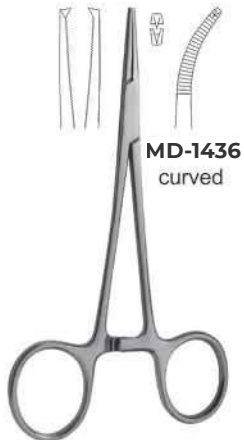

MD-1436
curved

Halstead Mosquito 1x2
MD-1435 125mm
straight

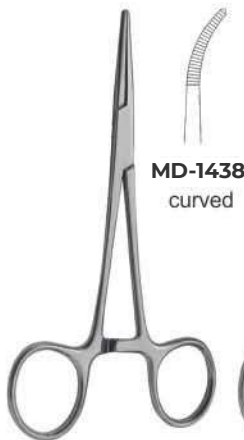

MD-1438
curved

Kelly
MD-1437 140mm
straight

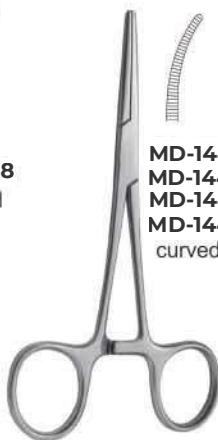

MD-1443 140mm
MD-1444 160mm
MD-1445 180mm
MD-1446 200mm
curved

Rochester-Pean
MD-1439 140mm
MD-1440 160mm
MD-1441 180mm
MD-1442 200mm
straight

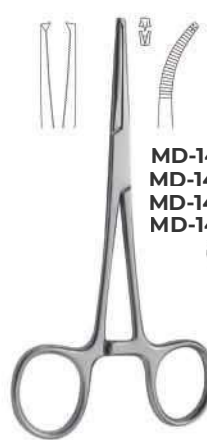

MD-1451 140mm
MD-1452 160mm
MD-1453 180mm
MD-1454 200mm
curved

Rochester-Kocher 1x2
140mm
MD-1448 160mm
MD-1449 180mm
MD-1450 200mm
straight

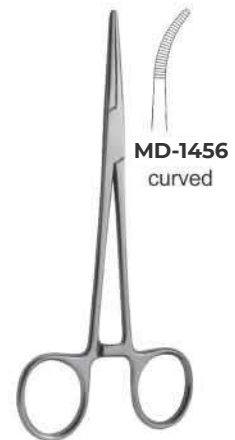

MD-1455
curved

MD-1455
Kelly-Rankin
160mm
straight

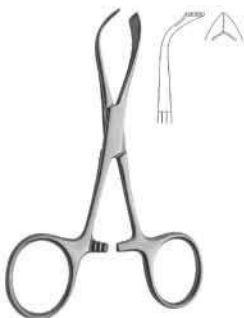

Lorna
MD-1457 100mm
MD-1458 130mm



MD-1459
Allis-Baby 3:4
150mm



MD-1460
Allis 4:5
200mm



MD-1461
Allis 6:7
200mm

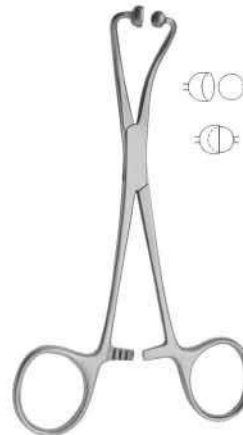

Ball Socket
MD-1462 140mm
Not-perforating and
not-damaging

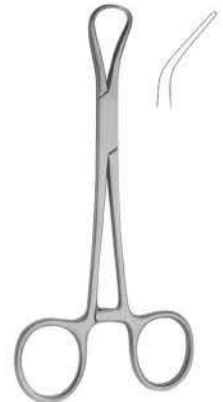

MD-1463
Backhaus
130mm



MD-1464
Backhaus
85mm



MD-1465
Jones
90mm



MD-1139
curved

Gross Maier
Dressing Forceps
MD-1466 200mm straight



Foerster
Dressina Forceps
MD-1467 200mm



Spare rubber

Young
Tongue Forceps
MD-1468 170mm



Collins
Tongue Forceps
MD-1469 170mm

RUBBER DAM CLAMPS FORCEPS

- Инструменты для системы коффердам
- Pinces porte-crampons a digue
- Kofferdam Klammerzangen
- Инструменти для системи коффердам
- Pinzas de engrapar para dique de caucho
- السد العظام الملقط المشابيك



MD-1470

On request the Content of the rubber dam kit can be changed with other instruments.

Content:

- 01 Anisworth
- 02 Brewer
- 03 Clamps Stand
- 04 Denture Plate
- 05 Rubber Dam Frame
- 06 Rubber Dam Box Lower Case
- 07 Rubber Dam Box Upper Case
- 08 Rubber Dam Clamp Fig. 212
- 09 Rubber Dam Clamp Fig. 211
- 10 Rubber Dam Clamp Fig. 8
- 11 Rubber Dam Clamp Fig. 8A
- 12 Rubber Dam Clamp Fig. 14
- 13 Rubber Dam Clamp Fig. 14A
- 14 Rubber Dam Clamp Fig. 0
- 15 Rubber Dam Clamp Fig. 00
- 16 Rubber Dam Clamp Fig. 2
- 17 Rubber Dam Clamp Fig. 2A
- 18 Rubber Dam Clamp Fig. 7



MD-1471
Small
Rubber Dam
Frame

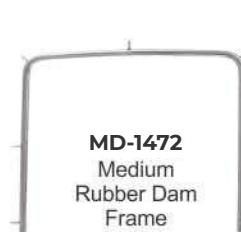

MD-1472
Medium
Rubber Dam
Frame



MD-1473
Large
Rubber Dam
Frame



MD-1474
Brewer



MD-1475
Stockes



MD-1476
Palmer



MD-1477
Ivory light weight



MD-1478
Anisworth



MD-1479
Anisworth



Punch Plier



MD-1480
Anisworth



MD-1481
Ivory



MD-1482
Separating
Elastic Plier

RUBBER DAM CLAMPS KITS



- Резиновая дамба зажимы комплекты
- Trousses de caoutchouc
- Gummidammklammern
- Гумова дамба затискачі комплекти
- Conjuntos de abrazaderas de retención de caucho
- المطاط السد المشابك مجموعات



MD-1483
Stainless Steel Gold Plated Rubber Dam Clamp Tray with 11 Different Clamps
Fig. 212, 211, 8, 8A, 14, 14A, 0, 00, 2, 2A, 7



MD-1484
Stainless Steel Rubber Dam Clamp Tray with 12 Different Clamps
Fig. 209, 212, 211, 8, 8A, 14, 14A, 0, 00, 2, 2A, 7



MD-1485
Stainless Steel Rubber Dam Clamp Tray with 8 Different Clamps
Fig. 1, 26, 29, 51, 60, 202, 205, 210



MD-1486
Stainless Steel Rubber Dam Clamp Tray
(without clamps)



MD-1487

On request the Content of the rubber dam kit can be changed with other instruments.

Content:

- 01 Ivory
- 02 Ivory light weight
- 03 Clamps Stand
- 04 Rubber Dam Frame M
- 05 Rubber Dam Frame L
- 06 Rubber Dam Box Lower Case
- 07 Rubber Dam Box Upper Case

- 08 Rubber Dam Clamp Fig. 209
- 09 Rubber Dam Clamp Fig. 212
- 10 Rubber Dam Clamp Fig. 211
- 11 Rubber Dam Clamp Fig. 8
- 12 Rubber Dam Clamp Fig. 8A
- 13 Rubber Dam Clamp Fig. 14
- 14 Rubber Dam Clamp Fig. 14A
- 15 Rubber Dam Clamp Fig. 0
- 16 Rubber Dam Clamp Fig. 00
- 17 Rubber Dam Clamp Fig. 2
- 18 Rubber Dam Clamp Fig. 2A
- 19 Rubber Dam Clamp Fig. 7

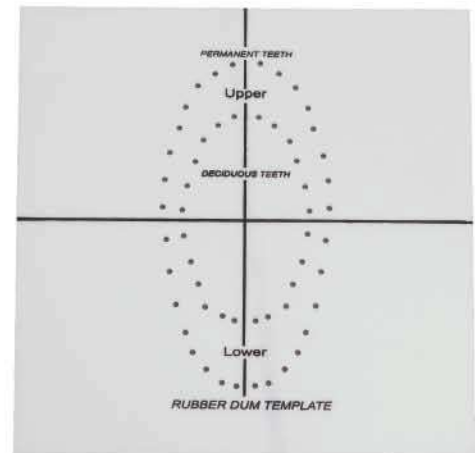

MD-1488
Rubber Dum Template

- Кляммера для коффердама
- Crampons pour digue
- Kofferdam Klammern
- Кляммера для коффердама
- Grapas para dique de caucho
- المشابك السد المطاط



MD-1489
Fig. 15



MD-1490
Fig. 18



MD-1491
Fig. 24



MD-1492
Fig. 25



MD-1493
Fig. 26



MD-1494
Fig. 28



MD-1495
Fig. 30



MD-1496
Fig. 31



MD-1497
Fig. 51



MD-1498
Fig. 138



MD-1499
Fig. 139



MD-1500
Fig. 200



MD-1501
Fig. 201



MD-1502
Fig. 202



MD-1503
Fig. 203



MD-1504
Fig. 204



MD-1505
Fig. 205



MD-1506
Fig. 3



MD-1507
Fig. W3



MD-1508
Fig. 4



MD-1509
Fig. 56A



MD-1510
Fig. 7



MD-1511
Fig. 7A



MD-1512
Fig. 8



MD-1513
Fig. 8A



MD-1514
Fig. W8A



MD-1515
Fig. 10



MD-1516
Fig. 11



MD-1517
Fig. 12A



MD-1518
Fig. 13A



MD-1519
Fig. 14



MD-1520
Fig. 14A



MD-1521
Fig. 14AN



MD-1522
Fig. 22



MD-1523
Fig. 27



MD-1524
Fig. 207



MD-1525
Fig. 29



MD-1526
Fig. 206



MD-1527
Fig. 208



MD-1528
Fig. 209



MD-1529
Fig. 1



MD-1530
Fig. 1A



MD-1531
Fig. 2



MD-1532
Fig. 2A



MD-1533
Fig. W2A



MD-1534
Fig. 0



MD-1535
Fig. 00



MD-1536
Fig. 210



MD-1537
Fig. 211



MD-1538
Fig. 212



MD-1539
Fig. 6



MD-1540
Fig. 9



MD-1541
Fig. N06



MD-1542
Fig. U67



MD-1543
Fig. 214



MD-1544
Fig. P1



MD-1545
Fig. P2



MD-1546
Fig. G-1



MD-1547
Fig. G-2

CROWN REMOVER



- Инструменты для удаления коронок
- Arrache-couronnes
- Teleskopkronenzangen
- Инструменти для видалення коронок
- Arranca-corona
- مزيلات التاج



MD-1548
Crown Spreaders



MD-1550
Universal
Fig. 0



Manual Crown Removers
Handle with 3 tips **DE-1551**
Only 3 tips **DE-1552 to DE-1554**



MD-1552 **MD-1553**



MD-1554



Manual Crown Removers
Handle with 3 tips **DE-1555**
Only 3 tips **DE-1556 to DE-1558**



MD-1556 **MD-1557**



MD-1558



MD-1559
Manual Crown
Remover



MD-1560
Manual Crown Remover

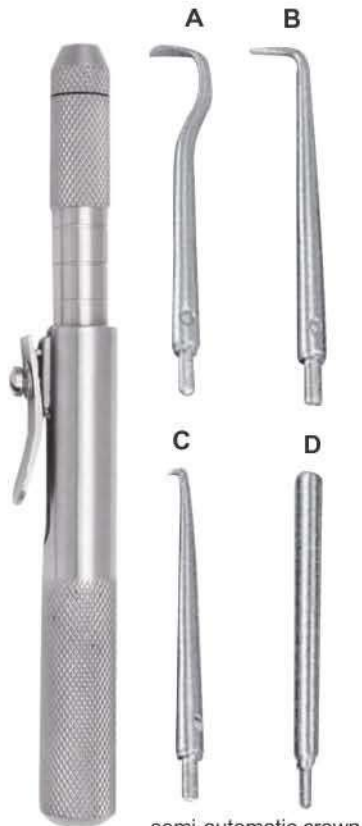

MD-1561
Complete with 3 tips
and tightening keys



MD-1562

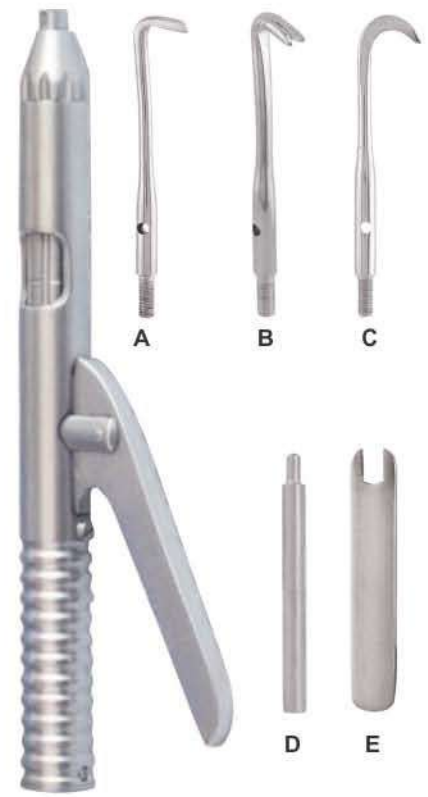

MD-1563
Manual Crown Remover

- Матрицедержатели
- Porte Matrices
- Matrizenspanner
- Матрицеутримувачи
- Porta Matrices
- مصغوفة الخدم



MD-1564
Fig. 5
Ivory 8
5 cm



MD-1565
Fig. 6
Ivory 8
6 cm



MD-1566
Fig. 7
Ivory 8
7 cm



MD-1567
Fig. 1
Tofflemire-Universal



MD-1568



MD-1569



MD-1570

Siqveland Retainers



MD-1571
Fig. 2
Tofflemire-Junior



MD-1572
Fig. 3
Tofflemire-Senior



MD-1573
Narrow



MD-1574
Wide

Amalgam Well



MD-1575
Stainless Steel
Amalgam Well



MD-1576
Ivory 12



MD-1577
Ivory 1



MD-1578
Ivory



MD-1579
Elliot

AMALGAM INSTRUMENTS



- Инструменты для амальгамы
- Instruments pour amalgame
- AmalgamisInstrumente
- Инструменти для амальгами
- Instrumentos para amalgama
- الصكوك الملغم



MD-1580
Fig. 10
165mm
English pattern



MD-1581
Fig. 1
185mm
German pattern



MD-1582
Fig. 1
150mm
Swiss pattern



MD-1583
Fig. 1
150mm



MD-1584
Fig. 2
150mm, 45°



MD-1585
Fig. 3
140mm, 90°



MD-1586
Chip Blower



MD-1587



MD-1588



MD-1589



MD-1590
Water Syringe

- Инструменты для амальгамы
- Instruments pour amalgame
- Amalgam-Instrumente
- Инструменти для амальгами
- Instrumentos para amalgama
- الصكوك الملعف

AMALGAM CARRIERS

TIP SIZES FOR DISTAL OR SINGLE-END

1.5 mm



MD-1592
Mini/
Single-End

2.0 mm



MD-1593
Regular
Single-End

2.8 mm



MD-1594
Large
Single-End

1.5 mm



MD-1595
Mini
Distal

2.0 mm



MD-1596
Regular
Distal

TIP SIZES FOR DOUBLE-END

1.5 mm



2.0 mm
MD-1597
Mini/
Regular

2.8 mm



2.0 mm
MD-1598
Large/
Regular

3.2 mm



2.0 mm
MD-1599
Jumbo/
Regular



MD-1600
Amalgam
Well



MD-1591
Single-End

TIP SIZES FOR DOUBLE-END

MD-1601 - 1.5mm-2.0mm **MD-1604** - 1.0mm-2mm
MD-1602 - 2.0mm-2.8mm **MD-1605** - 2.0mm-3mm
MD-1603 - 2.0mm-3.2mm **MD-1606** - 2.0mm-4mm

MD-1607 - 1.5mm-2.0mm **MD-1610** - 1.0mm-2mm
MD-1608 - 2.0mm-2.8mm **MD-1611** - 2.0mm-3mm
MD-1609 - 2.0mm-3.2mm **MD-1612** - 2.0mm-4mm

MD-1613 - 1.5mm-2.0mm **MD-1616** - 1.0mm-2mm
MD-1614 - 2.0mm-2.8mm **MD-1617** - 2.0mm-3mm
MD-1615 - 2.0mm-3.2mm **MD-1618** - 2.0mm-4mm

MD-1619 - 1.5mm-2.0mm **MD-1622** - 1.0mm-2mm
MD-1620 - 2.0mm-2.8mm **MD-1623** - 2.0mm-3mm
MD-1621 - 2.0mm-3.2mm **MD-1624** - 2.0mm-4mm

MD-1625 - 1.5mm
MD-1626 - 2.0mm
MD-1627 - 2.0mm
MD-1628 - 3.0mm

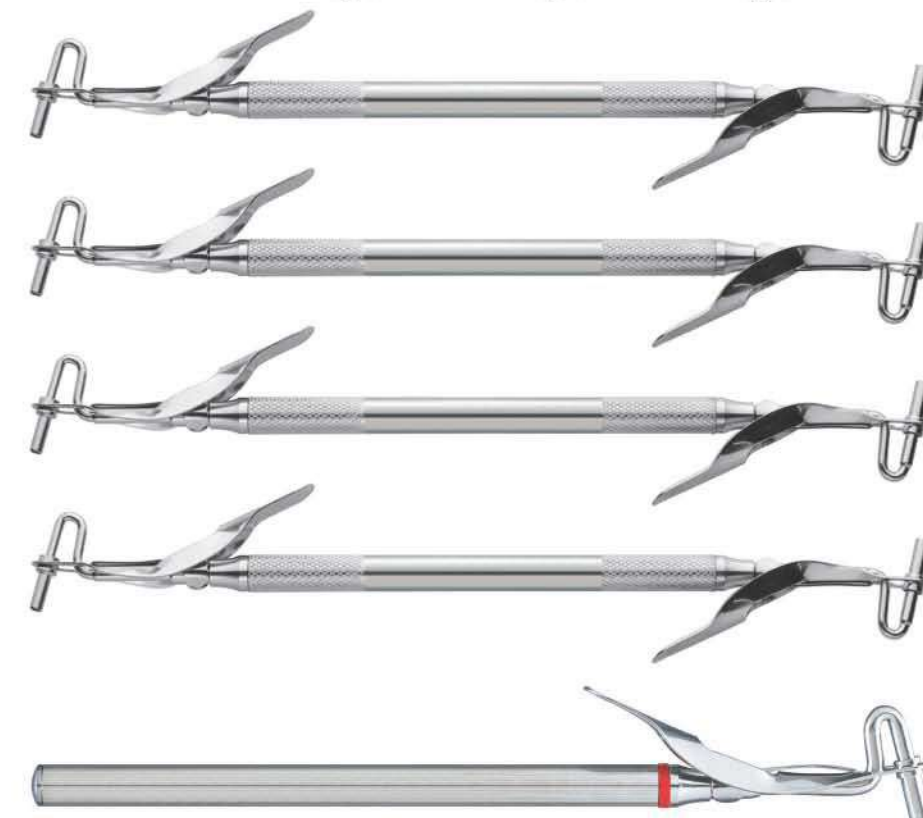



Periodontal Chisels

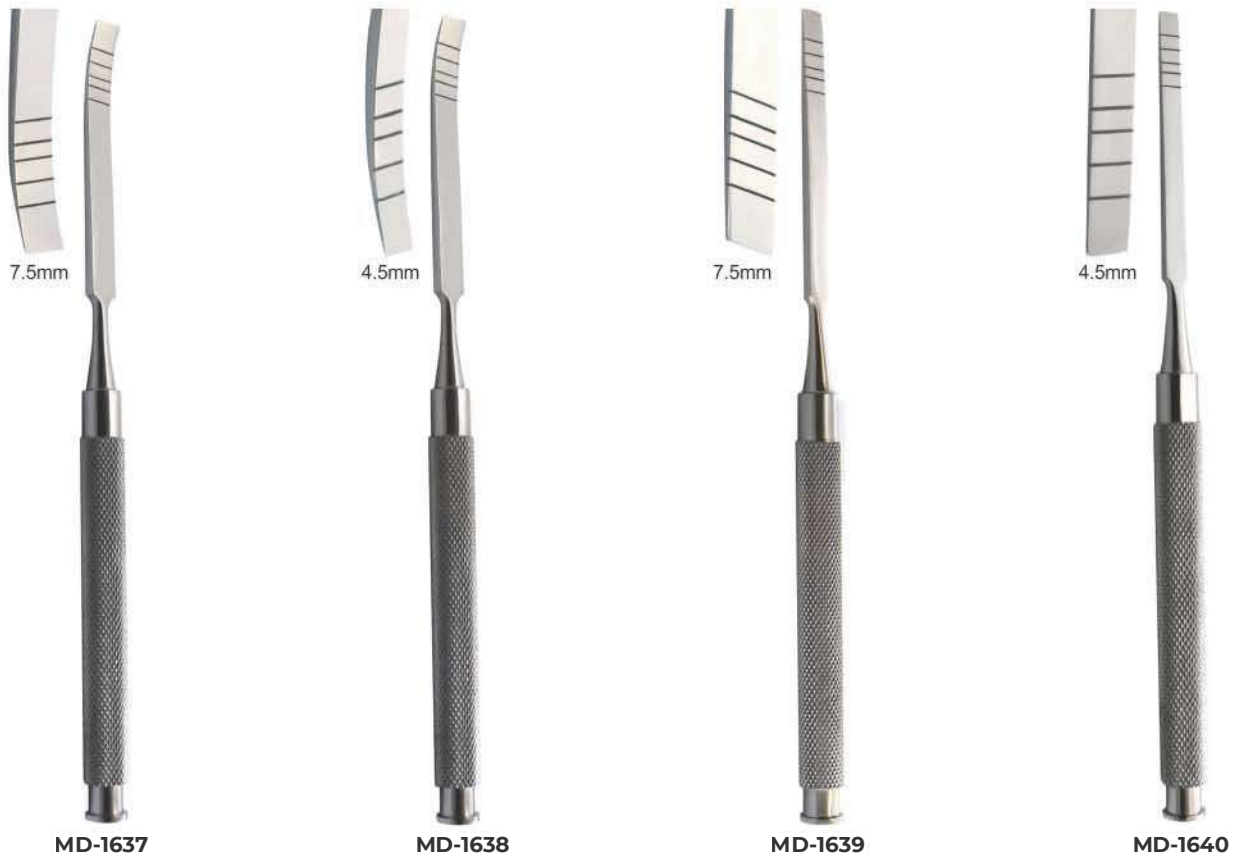

ROOT PLANNING FILES



MD-1641
Kramer-Nevins
Bone Chisel



MD-1642
Kramer-Nevins
Bone Chisel



MD-1643
Molt 18.5cm
Auto Clavable
Plastic Tips.

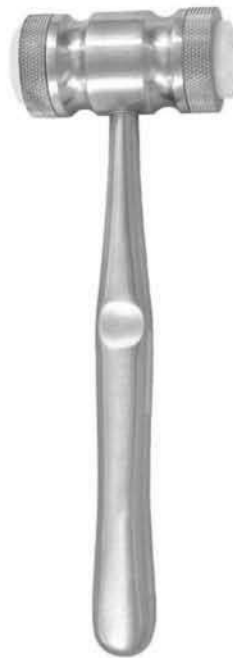

MD-1644
Mead 18.5cm
Non Auto Clavable
Plastic Tips.



MD-1645
Miller



MD-1646
Miller

BONE FILES



MD-1647
Miller 21



MD-1648
Miller 1X
cross cut



MD-1649
Miller 2X
cross cut



MD-1650
Miller 52



MD-1651
Wahl 1

PERIODONTAL INSTRUMENTS



- Инструменты пародонтологические
- Instruments pour la parodontologie
- Instrumente für die Parodontologie
- Інструменти пародонтологічні
- Instrumentos para periodoncia
- الصكوك اللثة

PERIOSTEEL ELEVATORS



MD-1652
Ohi 10



MD-1653
Howard 9H



MD-1654
Freer



MD-1655
Freer 15



MD-1656
Freer 16



MD-1657



MD-1658
Raspator, Raspatory
Length 175 mm



MD-1659



MD-1660



MD-1661



MD-1662

Raspator, Williger
Length 170 mm, different widths
(4 mm, 5 mm or 7 mm)



Partsch 140 mm
MD-1664 3mm
MD-1665 4mm
MD-1666 5mm
MD-1667 6mm



Partsch 170 mm
MD-1667 3mm
MD-1668 4mm
MD-1669 5mm
MD-1670 6mm



Partsch 140 mm
MD-1671 3mm
MD-1672 4mm
MD-1673 5mm
MD-1674 6mm

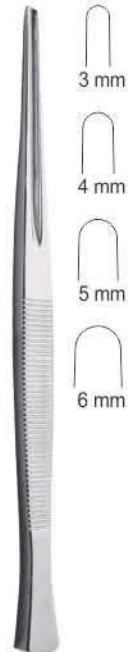

Partsch 170 mm
MD-1675 3mm
MD-1676 4mm
MD-1677 5mm
MD-1678 6mm

- Инструменты пародонтологические
- Instruments pour la parodontologie
- Instrumente für die Parodontologie
- Инструменти пародонтологічні
- Instrumentos para periodoncia
- الصغوك اللثة

To separate tissue tooth or bone. tp hold tissue away from surgical site.



PERIODONTAL INSTRUMENTS



- Инструменты пародонтологические
- Instruments pour la parodontologie
- Instrumente für die Parodontologie
- Інструменти пародонтологічні
- Instrumentos para periodoncia
- الصكوك اللثة



MD-1689



MD-1690
P24G



MD-1691
titanium Periosteal Elevator for Implan5



MD-1692
S1



MD-1693
Hirschfeld



MD-1694
9S



10mm

MD-1695
Selden

13mm

4.8 mm



Prichard

10.6 mm

MD-1696
Friedmann



MD-1697
Schmidlin

6.9 mm

SCALPEL HANDLES

- Ручки для скальпелей
- Manches de bistouris
- Skalpellgriffe
- Ручки для скальпелів
- Mangos de bisturi
- مشرط مقابض



MD-1698
Fig.3
12.7cm



MD-1699
Fig.3G
12.7cm



MD-1700
Fig.4
13.7cm



MD-1701
Double Handle
No.4 + No.3
16.3cm



MD-1702
Fig. 7
16.5cm



MD-1703
Scalpel Handle Straight
for blades #10-15
14.5cm



MD-1704
Micro Surgical Scalpel
Handle titanium
13.5cm



MD-1705
Fig. 5
14.5cm



MD-1706
Fig. 5A
14.5cm

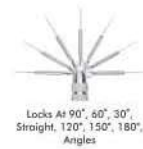

MD-1707
6 Way Adjustable Angled
Scalpel Handle

MALLETS - PLASTER SHEARS - SAWS & BLADES



MD-1708
Metal tip
220 mm
Hammer With Wooden Handle



MD-1709
Metal tip
220 mm



MD-1710
1
For plaster



MD-1711
2
For metal



MD-1712
Fret saw
250 mm



MD-1713
Small
Saw Blades



MD-1714
Large
Saw Blades



MD-1715
Ceri Saw



Special Inox
MD-1616 170mm
MD-1617 200mm



MD-1718
Plaster Shears
200 mm



Crucible Tongs
MD-1719 250 mm
MD-1720 320 mm



MD-1721
Ceri Saw
180 mm



MD-1722
Blade
0,12x5 mm
Conf. 12 pcs



MD-1723
Blade
0,25x5 mm
Conf. 12 pcs



MD-1724
Blade
0,25x3 mm
Conf. 12 pcs



Behind Every Smile is a Story

- QUALITY - ЯКІСТЬ
- PRECISION - ТОЧНІСТЬ
- ACCURACY - ПРАВИЛЬНІСТЬ
- DURABILITY - ЗНОСОСТІЙКІСТЬ



STYLE A

- Super-sharp diamond-honed cutters
- smooth ultra-polished and contoured edges
- brilliant corrosion resistant stainless steel finish
- superior T-12 stainless steel tool inserts
- sliding lock joint for balance & precision alignment

STYLE B

- Super-sharp (diamond-honed) cutters
- smooth ultra-polished and contoured edges
- brilliant corrosion resistant stainless steel finish
- superior T-12 stainless steel tool inserts
- sliding lock joint for balance & precision alignment

ORTHODONTIC INSTRUMENTS



- Инструменты ортодонтические
- Instrumentos Ortodonticos
- Orthodontische Instrumente
- Инструменти ортодонтични
- Instruments Orthodontiques
- أدوات تقويم الأسنان



MD-1800
Height Gauge 0.18
Aluminum



MD-1801
Height Gauge 0.22
Aluminum



MD-1802
Height Gauge 0.18
Stainless Steel



MD-1803
Height Gauge 0.22
Stainless Steel



MD-1804
Moveable
Height Gauge



MD-1805
Endo Finger
Ruler Span
Measure Scale



MD-1806
Endo Finger
Ruler Span
Measure Scale



MD-1807
Endo Finger
Ruler Span
Measure Scale



MD-1808
Positive
Positioner



MD-1809
Strip Saw



MD-1810
Bone Bracket Gauge



MD-1811
Endo Finger Ruler
Span Measure Scale



MD-1812
Endo Finger Ruler
Span Measure Scale

- Инструменты ортодонтические
- Instrumentos Ortodonticos
- Orthodontische Instrumente
- Инструменти ортодонтични
- Instruments Orthodontiques
- أدوات تقويم الأسنان



MD-1813
Measuring Loop
angled, length
175 mm,
measuring range
0 - 40 mm



MD-1814
Measuring Loop
straight length
175 mm,
measuring range
0 - 40 mm



MD-1815
Measuring loop, Castroviejo
angled, length 175 mm,
measuring range 0 - 40 mm,
with window



MD-1816
Measuring Loop
straight length 90 mm,
measuring range
0 - 40 mm,
MD-1817
Castroviejo Calipers
20mm
90mm



MD-1818
Measuring Loop
angled, length 90 mm,
measuring range
0 - 40 mm,
MD-1819
Castroviejo Calipers
20mm, 45°
90mm



MD-1820
Castroviejo Calipers
20mm
90mm



MD-1821
Fig. 1
Iwanson
spring caliper
For metal and
porcelain.



MD-1822
Fig. 2
Iwanson
spring caliper
For wax.

ORTHODONTIC INSTRUMENTS



- Инструменты ортодонтические
- Instrumentos Ortodonticos
- Orthodontische Instrumente
- Инструменти ортодонтични
- Instruments Orthodontiques
- أدوات تقويم الأسنان



MD-1823
Boley Gauge



MD-1824
Vernier Gauge



MD-1825
Aluminium Caliper
up to 200mm



MD-1826
Boley Gauge



MD-1827
Delux Boley
Gauge



MD-1828
Beerendonk
130mm
Mini Gauge



MD-1829
Compasso
De Willis



MD-1830
Dentaurum
Ruler



MD-1831
Ruler Wedge



MD-1832
Ruler

- Инструменты ортодонтические
- Instrumentos Ortodonticos
- Orthodontische Instrumente
- Инструменти ортодонтичні
- Instruments Orthodontiques
- أدوات تقويم الأسنان

Bracket Holder Tweezers



MD-1833
Deluxe Bracket
Holder Tweezers



MD-1834
Deluxe Bracket
Holder Tweezers



MD-1835
Direct Bond Bracket
Holder Tweezers



MD-1836
Bracket Tweezers
Slot Aligner



MD-1837
Direct Bond
Bracket Holder
Tweezers, Small Tip



MD-1838
Exact Bracket
Holder Tweezers



MD-1839
Bracket Placing
Tweezers



MD-1840
Easy Access
Tweezers



MD-1841
Bracket Placer
Tweezers
(Extra Fine Tip)



MD-1842
Deluxe Bracket
Holder Tweezers
135mm



MD-1843
Easy Eccess
Tweezers



MD-1844
Slipper
Tweezers



MD-1845
Direct Bonding
Bracket Holders
135mm



MD-1846
Direct Bonding
Bracket Holders
136mm



MD-1847
Direct Bonding
Bracket Holders
135mm



MD-1848
Deluxe Bracket
Holder



MD-1849
Direct Bonding
Bracket Holders
140mm

ORTHODONTIC INSTRUMENTS



- Инструменты ортодонтические
- Instrumentos Ortodonticos
- Orthodontische Instrumente
- Инструменти ортодонтични
- Instruments Orthodontiques
- ادوات تقويم الأسنان



MD-1850
Band seater
auto cleavable



MD-1851
Band seater
auto cleavable
Triangle Shape



MD-1852
Band seater
auto cleavable
Square Shape



MD-1853
Band seater
auto cleavable
Round Shape



MD-1854
Mershon Band
Pusher
140mm



MD-1855
Band seating &
removing
instruments



MD-1856
Ortho Light double
ended
ligature director
scaler



MD-1857
Ortho Light Band
Pusher Scaler



MD-1858
Band Seating &
Removing
Silicon Grip



MD-1859
Ligature Instrument
Silicon Grip



MD-1860
Elastic Instrument
Silicon Grip



MD-1861
Distal Bender
Silicon Grip



MD-1862
Distal Bender
Silicon Grip



MD-1863
Distal Bender
Silicon Grip

- Инструменты ортодонтические
- Instrumentos Ortodonticos
- Orthodontische Instrumente
- Инструменти ортодонтични
- Instruments Orthodontiques
- ادوات تقويم الأسنان



MD-1864
Ortho light scaler double ended



MD-1865
Ortho light scaler double ended



MD-1866
Ortho light scaler double ended



MD-1867
Twiel-on elastic module instrument



MD-1868
Twiel-on elastic module instrument



MD-1869
Schure Band Seater



MD-1870
Ortho light scaler



MD-1871
Ortho light scaler



MD-1872
Ortho light scaler heavy



MD-1873
Ortho instrument



MD-1874
Ortho instrument

ORTHODONTIC INSTRUMENTS



- Инструменты ортодонтические
- Instrumentos Ortodonticos
- Orthodontische Instrumente
- Инструменти ортодонтични
- Instruments Orthodontiques
- ادوات تقويم الأسنان



MD-1875
Ortho Light double ended
ligature director



MD-1876
Ortho Light double ended ligature scaler director tivate coil spring
are remove modules with one instruments



MD-1877
Ortho band pusher scaler



MD-1878
Ortho ligature director single ended



MD-1879
Ortho Light double ended ligature
director scaler



MD-1880
Ortho Light double ended ligature scaler/director
tivate coil spring are remove modules with one instruments



MD-1881
Ortho Light double ended ligature director



MD-1882
Ortholite Ligature Director Scaler



MD-1883
Ortho light ligature director double ended



MD-1884
Double ended cement spatula



MD-1885
Ortho light scaler single ended

- Щипцы для ортодонтии и протезирования
- Pincettes pour l'orthodontie et la prothèse
- Zangen für Kieferorthopädie und Prothetik
- Щипці для ортодонції та протезування
- Alicates para ortodoncia y prótesis
- كماشة لتقويم الأسنان بروسٹیتس

BOX JOINT PLIERS

MD-1886

Universal Dolphin Style
Wire Bending & cutting pliers



MD-1892

Bracket Removing Plier curved
Bracket Removing Plier curved for
easy removal of brackets in the
posterior region. Length 130mm



MD-1887 Band Removing Plier

The curved blade of the band
removing plier can strip easily
and gently remove directly to
the tooth. Length 130mm



MD-1893

Young Wire Bending &
Loop Forming Pliers



MD-1888

Tweed Loop
forming Pliers



MD-1894

Wire Bending &
Loop Forming Pliers



MD-1889

How Plier curved
Universally usable tool for
the multiband technology for
wires up to .028".
Length 130mm



MD-1895

Adams, small wire bending
and loop forming Pliers



MD-1890 How Plier

Universally usable tool for the
multiband technology for wires
up to .028".
Length 135mm



MD-1896

Bracket Removing Plier Round Box
Bracket removing plier for comfortable
and quick removal of the brackets.
Length 135mm



MD-1891

Nance Loop
forming Pliers



MD-1897

Weingart Plier medium
Weingart plier that are ideal due to
their curved tip for setting sheets and
is capable of bending the ends.
Length 145mm



PLIERS FOR ORTHODONTICS & PROSTHETICS



- Щипцы для ортодонтии и протезирования
- Pincers pour l'orthodontie et la prothèse
- Zangen für Kieferorthopädie und Prothetik
- Щипці для ортодонції та протезування
- Alicates para ortodoncia y prótesis
- كمشاة لتقويم الأسنان بروتستیس

BOX JOINT PLIERS

MD-1898 Adams Plier Round Box
Adams pliers for bending wire arches and bends right angles for wires up to .022", .025 tip to beak. Length 125mm



MD-1899 Falcon Beak Contouring Pliers.



MD-1900
wires up to 0.020" / 0.7mm.



MD-1901 Johnson Contouring Pliers



MD-1902 Aderer
Large wire bending and loop forming pliers



MD-1903 Tweed / angle rectangular arch forming & Torquing pliers



MD-1904 Adams Plier
Adams pliers for bending wire arches and bends right angles for wires up to .022", .025 tip to beak. Length 125mm

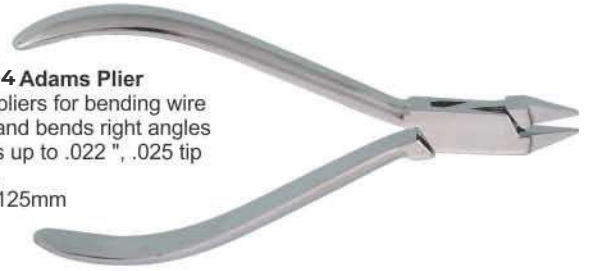

MD-1905 Tweed Loop Formin Pliers



MD-1906 Bird Beak Plier Standard
Bird Beak Wire bending plier without notches, which is suitable as a universal utility tool. Length 125mm



MD-1907 Mini Ligature cutters



MD-1908 Small Fluch-cut distal and cutting Pliers
with safety hold fitted with un-breakable, corrosion resistant and durable stainless steel tips



MD-1909 Large Fluch-cut distal and cutting Pliers
with safety hold fitted with un-breakable, corrosion resistant and durable stainless steel tips



- Щипцы для ортодонтии и протезирования
- Pincettes pour l'orthodontie et la prothèse
- Zangen für Kieferorthopädie und Prothetik
- Щипці для ортодонції та протезування
- Alicates para ortodoncia y prótesis
- كماشة لتقويم الأسنان بروستتیس

BOX JOINT PLIERS

MD-1910

Tweed / Angel
1.78mm (.070") wide tips arch forming and torquing pliers



MD-1916

Contouring Plier



MD-1911

Tweed / Angel
1.78mm (.070") wide tips arch forming and torquing pliers



MD-1917

Bands & Crowns Plier
in order to skirt



MD-1912

Lingual / Palatal arch forming pliers



MD-1918

Ligature Forming Pliers



MD-1913

Aderer
Facebow loop forming Pliers



MD-1919

for double back and triple back bands in 0.30" / 0.76mm & 0.36" / 0.91mm lingual arch wires



MD-1914

Waldsavhs wire bending and cutting pliers



MD-1920

Bird Beak Wire Bending & cutting pliers



MD-1915 Aderer Plier

For the manufacturing of appliances and activation of wires for wires up to .030" .fine tip and up to .036" mean tip.
Length 130mm



MD-1921

Weingart Plier medium
Weingart plier that are ideal due to their curved tip for setting sheets and is capable of bending the ends.
Length 145mm



PLIERS FOR ORTHODONTICS & PROSTHETICS



- Щипцы для ортодонтии и протезирования
- Pincers pour l'orthodontie et la prothèse
- Zangen für Kieferorthopädie und Prothetik
- Щипці для ортодонції та протезування
- Alicates para ortodoncia y prótesis
- كمامة لتقويم الأسنان بروسثیتیس

L-KEY JOINT PLIERS



MD-1922

Distal end cutter with safety hold, mini head, long handles. fitted with un-breakable, corrosion resistant and durable stainless steel tips

- 0.30 mm to 0.50 mm (.012" to .020")
- Max. 0.46 mm x 0.64 mm (.018" x .025")
- ⊗ 0.38 mm to 0.53 mm (.0155" to .0215")
- ⊗ Max. 0.53 mm x 0.64 mm (.021" x .025")



MD-1923

Flush-cut distal end cutter with safety hold fitted with un-breakable, corrosion resistant and durable stainless steel tips

- 0.30 mm to 0.50 mm (.012" to .020")
- Max. 0.46 mm x 0.64 mm (.018" to .025")



MD-1924

Soft wire and ligature cutter, Mini fitted with un-breakable, corrosion resistant and durable stainless steel tips

- ☞ .25 mm to .38 mm (.010" to .015")



MD-1925

Soft wire and ligature cutter, standard fitted with un-breakable, corrosion resistant and durable stainless steel tips

- ☞ .25 mm to .38 mm (.010" to .015")



MD-1926

Soft wire and ligature cutter, 15° angled fitted with un-breakable, corrosion resistant and durable stainless steel tips

- ☞ .25 mm to .38 mm (.010" to .015")



MD-1927

Soft wire and ligature cutter, 45° angled fitted with un-breakable, corrosion resistant and durable stainless steel tips

- ☞ .25 mm to .38 mm (.010" to .015")



MD-1928

Hard wire cutter, straight Fitted with un-breakable, corrosion resistant and durable stainless steel tips

- 0.30 mm to 0.50 mm (.012" to .020")
- Max. 0.56 mm x 0.71 mm (.022" x .028")



MD-1929

Hard wire cutter, 15° angled Fitted with un-breakable, corrosion resistant and durable stainless steel tips

- 0.30 mm to 0.50 mm (.012" to .020")
- Max. 0.56 mm x 0.71 mm (.022" x .028")



MD-1930

Hard wire cutter, 15° angled Non-autoclavable

- 0.30 mm to 0.50 mm (.012" to .020")
- Max. 0.56 mm x 0.71 mm (.022" x .028")

- Щипцы для ортодонтии и протезирования
- Pincen pour l'orthodontie et la prothèse
- Zangen für Kieferorthopädie und Prothetik
- Щипці для ортодонтії та протезування
- Alicates para ortodoncia y prótesis
- كماشة لتقويم الأسنان بروسٹیتس

L-KEY JOINT PLIERS



MD-1931
Band removing pliers



MD-1936
Weingart-mini
Utility Pliers

- 0.30 mm to 0.50 mm (.012" to .020")
- Max 0.56 mm x 0.71 mm (.022" x .028")



MD-1932
Bracket removing pliers angled



MD-1937
Weingart
Utility Pliers

- 0.30 mm to 0.50 mm (.012" to .020")
- Max 0.56 mm x 0.71 mm (.022" x .028")

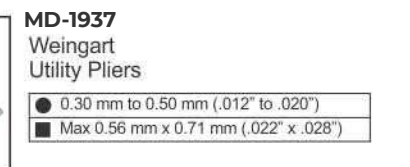

MD-1933
Bracket removing pliers straight



MD-1938
How Straight
Utility Pliers

- 0.30 mm to 0.50 mm (.012" to .020")
- Max 0.56 mm x 0.71 mm (.022" x .028")



MD-1934
Bracket removing pliers with plastic tip



MD-1939
Angled
Utility Pliers

- 0.30 mm to 0.50 mm (.012" to .020")
- Max 0.56 mm x 0.71 mm (.022" x .028")

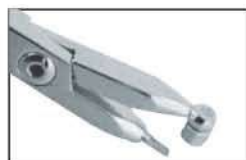
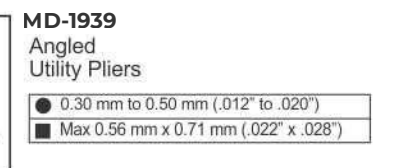

MD-1935
Adhesive removing pliers



MD-1940
Wire bending and loop forming pliers
Angled (Bird beak)

- 0.30 mm to 0.50 mm (.012" to .020")
- Max 0.56 mm x 0.71 mm (.022" x .028")



PLIERS FOR ORTHODONTICS & PROSTHETICS



- Щипцы для ортодонтии и протезирования
- Pincers pour l'orthodontie et la prothèse
- Zangen für Kieferorthopädie und Prothetik
- Щипці для ортодонції та протезування
- Alicates para ortodoncia y prótesis
- كمشة لتقويم الأسنان بروتستیس

L-KEY JOINT PLIERS



MD-1941
Multi-purpose pliers, bird beak,
De la rosa and cutter in one

- 0.30 mm to 0.50 mm (.012" to .020")
- Max. 0.46 mm x 0.56 mm (.018" x .028")



MD-1946
Stop pliers V-Bebd - 1mm

- 0.30 mm to 0.50 mm (.012" to .020")
- Max. 0.43 mm x 0.56 mm (.017" x .028")



MD-1942
Cinch Back / tie back
Distal end bending pliers

- 0.30 mm to 0.50 mm (.012" to .020")
- Max. 0.56 mm x 0.71 mm (.022" x .028")



MD-1947
Lingual / palatal arch forming pliers

- 0.76 mm (.030") / 0.91 mm (.036")



MD-1943
Hammer head
Distal end bending pliers

- 0.30 mm to 0.50 mm (.012" to .020")
- Max. 0.56 mm x 0.71 mm (.022" x .028")



MD-1948
Torquing pliers set



MD-1944
Nance
Loop forming pliers

- 0.36 mm to 0.71 mm (.014" to .028")
- Max. 0.56 mm x 0.71 mm (.022" x .028")



MD-1949
Tweed / angel
Rectangular arch forming and
torquing pliers

- 0.30 mm to 0.71 mm (.012" to .028")
- Max. 0.56 mm x 0.71 mm (.022" x .028")



MD-1945
Detailing step pliers / Bayonet
bending pliers - 1mm

- 0.30 mm to 0.50 mm (.012" to .020")
- Max. 0.56 mm x 0.71 mm (.022" x .028")



MD-1950
Surgical ball hook crimping pliers,
angled



MD-1951
Surgical ball hook crimping
pliers, straight

- Щипцы для ортодонтии и протезирования
- Pincers pour l'orthodontie et la prothèse
- Zangen für Kieferorthopädie und Prothetik
- Щипці для ортодонції та протезування
- Alicates para ortodoncia y prótesis
- كماشة لتقويم الأسنان بروسٹیتس

L-KEY JOINT PLIERS

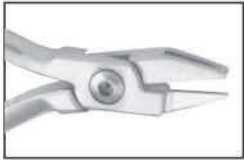

MD-1952
Aderer Clamp three jaw wire bending plier for contouring and bending wire up to .30"/.76mm.



MD-1958
Falcon beak contouring plier.

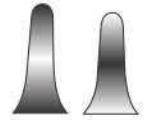

MD-1953
Bird beak plier for bending round, square and rectangle wire up to .30"/.76mm.

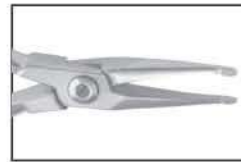
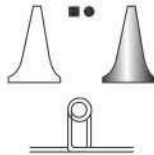

MD-1959
For placement and removal of arch wires, pins and other auxiliaries.



MD-1954
Bird beak plier for light wire bending round, square and rectangular up to .016"/0.41mm.

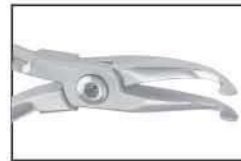
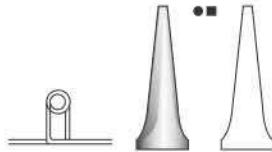

MD-1960
For placement and removal of arch wires, pins and other auxiliaries in angle design



MD-1955
Double Rounded jaw bending pliers, hooks and wire up to .020"/0.51mm.

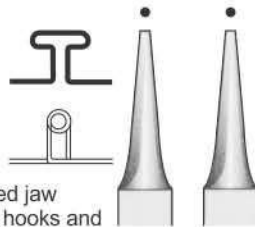

MD-1961
contouring Plier.



MD-1962
Bending plier. In order to skirt molares bands. With grooved. Recommended wire. 016", 018" and 022" 0.41mm, 0.46mm and 0.56mm



MD-1956
Adams pliers for hooks and bending wire up to .030"/0.76mm.

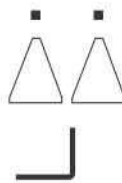

MD-1963
Loop forming in four length 3,4,5 & 6 mm wire capacity 0.22", 56mm.

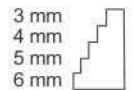

MD-1957
Johnson pliers for crown band contouring



MD-1964
Arch bending plier design for convenient handling of square or rectangular wire, .020" / 0.51mm.



PLIERS FOR ORTHODONTICS & PROSTHETICS



- Щипцы для ортодонтии и протезирования
- Pincers pour l'orthodontie et la prothèse
- Zangen für Kieferorthopädie und Prothetik
- Щипці для ортодонції та протезування
- Alicates para ortodoncia y prótesis
- كمشة لتقويم الأسنان بروستیتیس

LAP & L-KEY JOINT PLIERS



MD-1965
In order to skirt bands and crowns.



MD-1966
Wires up to .020" / 0.7mm.

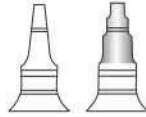

MD-1967
Round and concave plier for loop forming and banding wire up to .20" / .051mm.



MD-1968
Bending for round square or rectangular wire up to 0.30"/0.76mm



MD-1969
for double back and triple back bands in 0.30" / .76mm & 0.36" / .91mm lingual arch wires.



MD-1970
Detailing step plier double-sided offset beak permits bayonet bends. Creates right hand or left hand step-up or stepdown at 1/2, 3/4, or 1mm increments.

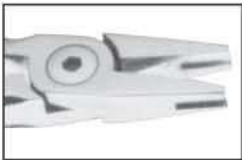

MD-1971
"V" bend stop special design makes 1mm "v" bends to shorten archwires or provide a positive stop. Excellent for placing stops in titanium wires. For round or rectangular wires up to .025"

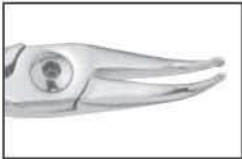

MD-1972
Angle how plier efficient utility plier with serrated beaks for a firm grip. 45 angled tips to access hard to reach areas.

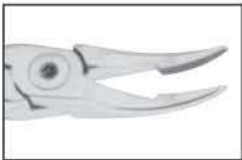

MD-1973
Weingardt plier serrated tips hold wires firmly at a convenient working angle. Tapered beaks fit easily between brackets and hard to reach areas. Our most popular utility plier.



MD-1974
Pin & Ligature Cutters TC.



MD-1975
Mini Pin & Ligature Cutter TC.



MD-1976
Standard Ligature Cutter TC.



MD-1977
V Bend Stop Plier TC.



MD-1978
Angled Direct Bond Bracket Remover TC.



MD-1979
Cutter Str.



Distal Cutter
14cm
MD-1980 2.5 mm
MD-1981 3.0 mm
MD-1982 3.0 mm



MD-1983
Arrow Clasp Forming Pliers
12.0cm



MD-1984
Schwarz
12.5cm



MD-1985
Distal end Cutter, Safety Hold Plier
(Ideal for Cutting Wire) TC.



MD-1986
Hook Crimping Plier Angled
Straight TC.



MD-1987
3 Prong Clasp Adjustable
Plier TC.



MD-1988
Utility Plier Weingart TC.



MD-1989
Direct Bracket Remover
TC.



MD-1990
Straight Direct Bond Bracket
Remover TC.



MD-1991
Pin Holding Plier TC.



MD-1992
Hard wire cutters



MD-1993
Elastic Separating Plier
Round Handle



MD-1994
Elastic
Separating Plier



MD-1995 Str.
MD-1996 Cvd.
Smaha
Elastomeric
ligature
placing forceps
140 mm



MD-1997
Elastomeric
ligature placing
forceps with
groove
Falcon 140 mm



MD-1998
Elastomeric
ligature placing
forceps with
groove
Falcon 140 mm



PLIERS FOR ORTHODONTICS & PROSTHETICS



- Щипцы для ортодонтии и протезирования
- Pincas pour l'orthodontie et la prothèse
- Zangen für Kieferorthopädie und Prothetik
- Щипці для ортодонції та протезування
- Alicates para ortodoncia y prótesis
- كماشة لتقويم الاسنان بروتیستیس

CUTTER, UTILITY PLIERS & WIRE FORMING PLIERS



MD-1999
Weingart Pliers



MD-2004
Adhesive
Removing Pliers



MD-2000
Slim Weingart
Pliers

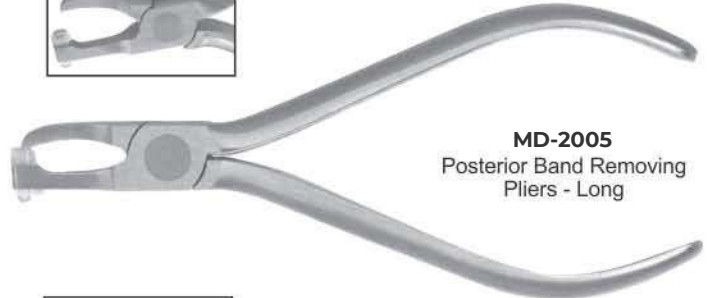

MD-2005
Posterior Band Removing
Pliers - Long



MD-2001
How Pliers
Straight

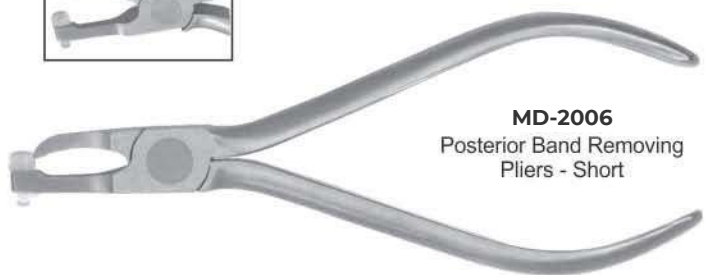

MD-2006
Posterior Band Removing
Pliers - Short



MD-2002
How Pliers Offset

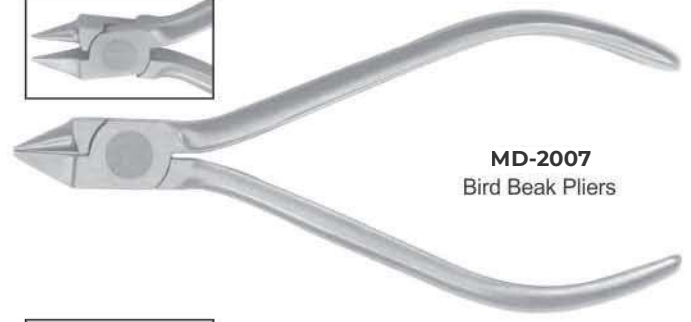

MD-2007
Bird Beak Pliers

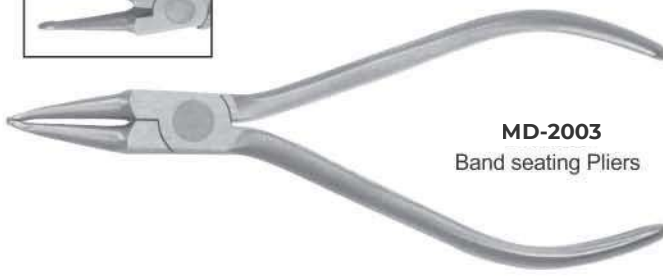

MD-2003
Band seating Pliers

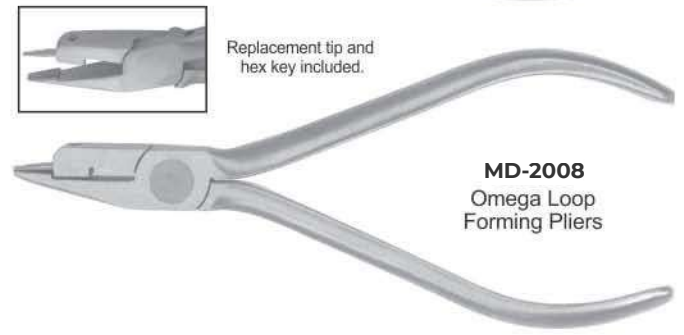

Replacement tip and
hex key included.

MD-2008
Omega Loop
Forming Pliers

- Щипцы для ортодонтии и протезирования
- Pincers pour l'orthodontie et la prothèse
- Zangen für Kieferorthopädie und Prothetik
- Щипці для ортодонції та протезування
- Alicates para ortodoncia y prótesis
- كماشة لتقويم الأسنان بروستيثيس

CUTTERS



MD-2009
Hard
Wire Cutter 15

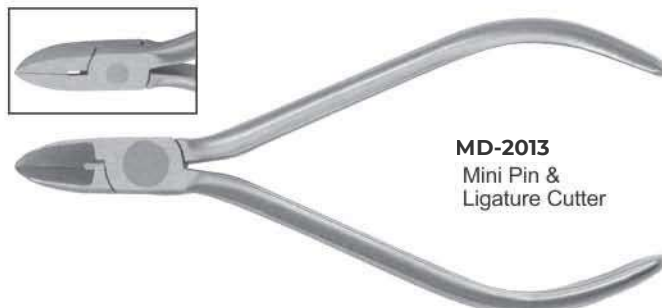

MD-2013
Mini Pin &
Ligature Cutter

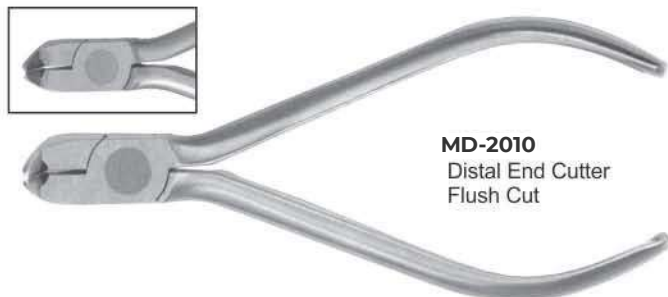

MD-2010
Distal End Cutter
Flush Cut



MD-2014
Hard Wire Cutter
Straight

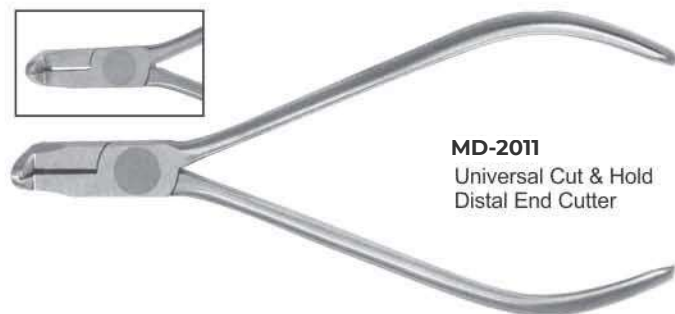

MD-2011
Universal Cut & Hold
Distal End Cutter

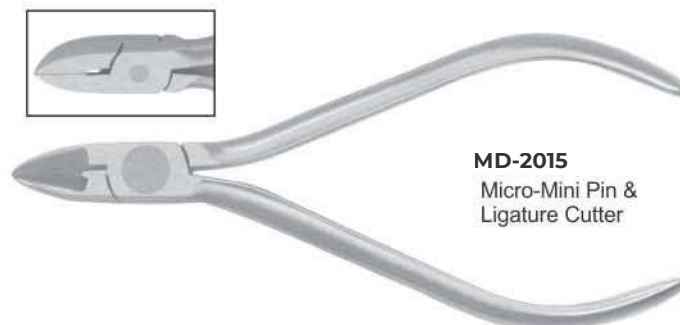

MD-2015
Micro-Mini Pin &
Ligature Cutter

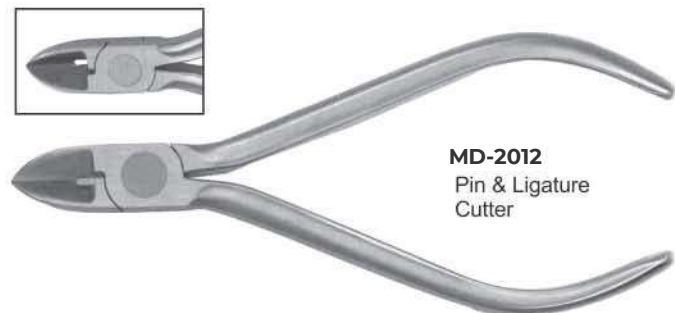

MD-2012
Pin & Ligature
Cutter



MD-2016
Cutter

PLIERS FOR ORTHODONTICS & PROSTHETICS



- Щипцы для ортодонтии и протезирования
- Pincas pour l'orthodontie et la prothèse
- Zangen für Kieferorthopädie und Prothetik
- Щипці для ортодонції та протезування
- Alicates para ortodoncia y prótesis
- كماشة لتقويم الأسنان بروستیتیس



MD-2017
Three Jaw Pliers

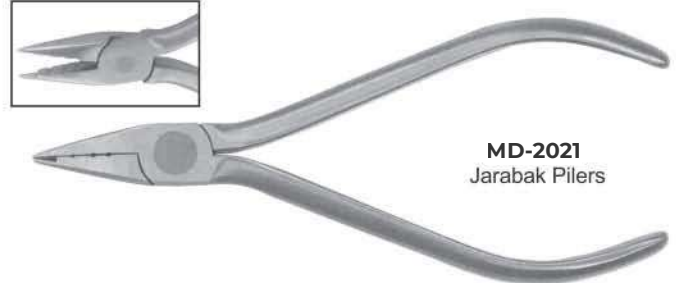

MD-2021
Jarabak Pliers

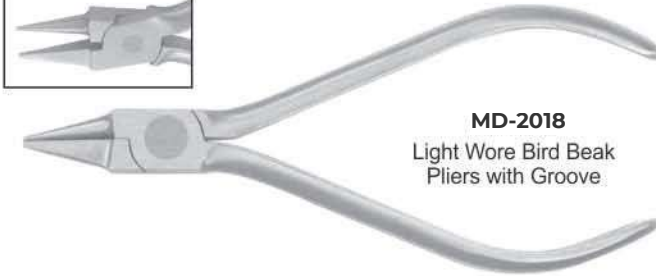

MD-2018
Light Wore Bird Beak
Pliers with Groove



MD-2022
Hollow Chop
Contouring Pliers

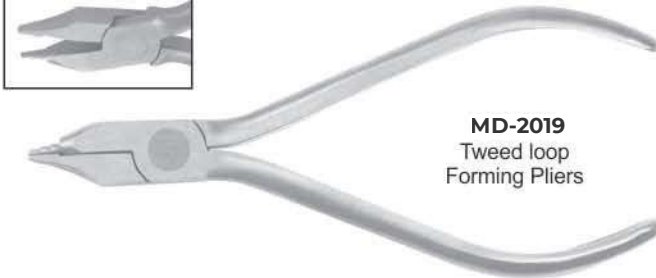

MD-2019
Tweed loop
Forming Pliers



MD-2023
Lingual Arch
Forming Pliers



MD-2020
Arch Bending Pliers



MD-2024
Rectangular Arch
Bending Pliers

- Ортодонтия Щипцы Подставки
- Supports de pinces d'orthodontie
- Kieferorthopädie Zangenständer
- Ортодонтия Щипці Підставки
- KFO Zangen Ständer
- تقويم الأسنان كماشة تقف



MD-2025
Plier Stand
Stainless Steel.



MD-2026
Plier Stand
Stainless Steel.



MD-2027
Pliers Stand
Stainless Rod
(Aluminum Anodized)
Stainless Steel



MD-2028
Plier Stand
Stainless Steel.



MD-2029
Plier Stand
Stainless Steel.



MD-2030
Plier Stand
Plastic

Normal Anatomy – Dental Implants

Bone Level Normal
(No Bone Loss)

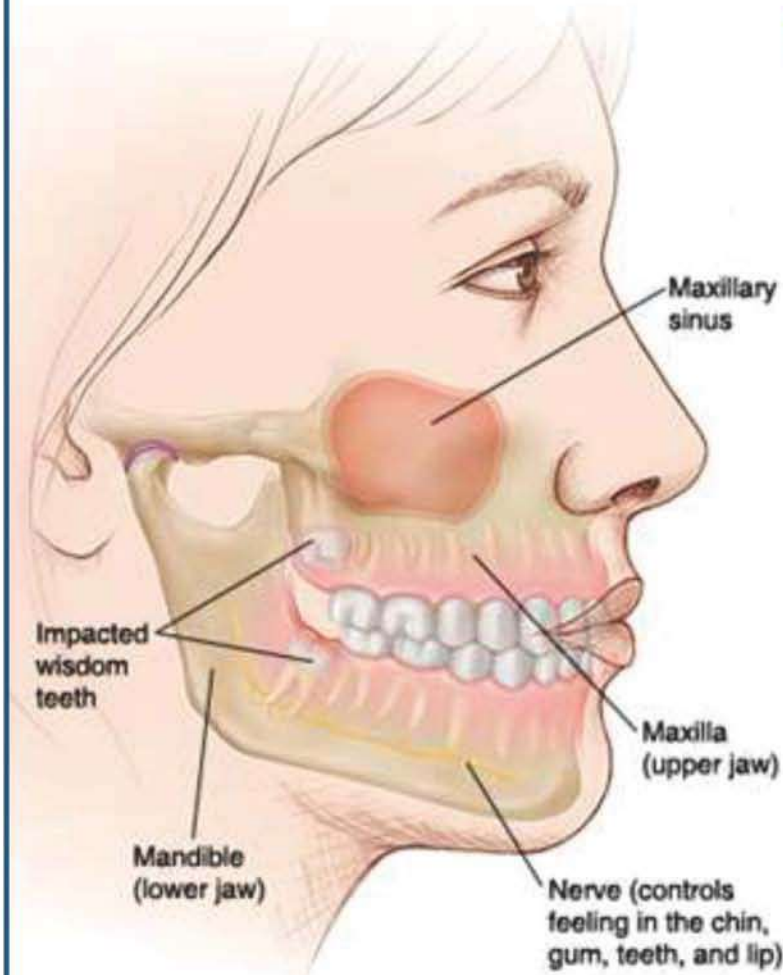
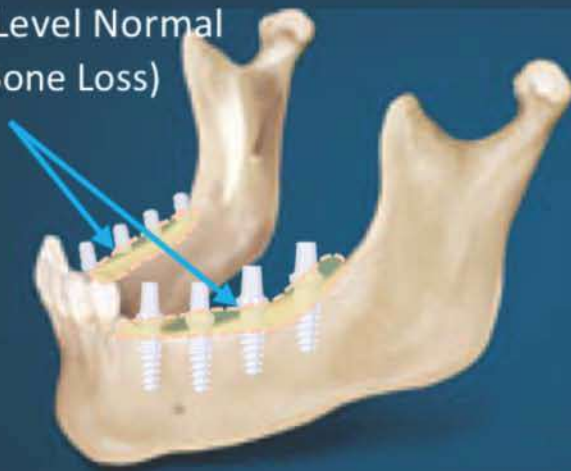

- Инструменты для имплантологии
 - Implantologie
 - Implantologie
- Інструменти для імплантології
 - Implantologia
 - زراعة الأسنان

IMPLANT GAGES



MD-2100

Multifunctional Meter
Length 90 mm,
different sizes,
8-10-11mm,
corrosion-resistant

MD-2101

Multifunctional Meter
Length 90 mm,
different sizes,
5-13-15-17 mm,
corrosion-resistant

MD-2102

Measuring Probe
Length 170 mm,
hand shape or flexible
(6-8-10-14-16 mm),
corrosion-resistant

MD-2103

MD-2104

MD-2105

MD-2106

IMPLANT GAGES



MD-2107

MD-2108

MD-2109

IMPLANTOLOGY



- Инструменты для имплантологии
- Implantologie
- Implantologie

- Инструменти для імплантології
- Implantologia
- زراعة الأسنان



MD-2110
Ridge Mapping
Double Caliper



MD-2111
Bone Thickness Gauge
40mm, 180mm



MD-2112
Osteometer
Measuring Forceps For Jaw
Ridge Width measurement, scale
on both sides, rustfree, autoclavable

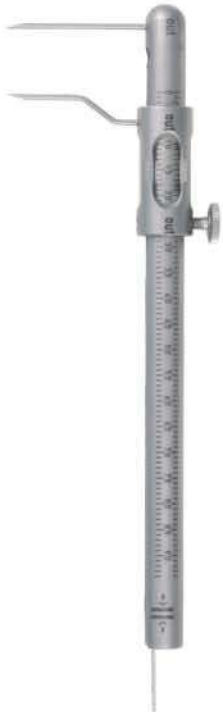

MD-2113
Micro Boley
Gauge Twisted



MD-2114
Micro Boley
Gauge Straight



MD-2115
Ortho Ruler / Cone Socket

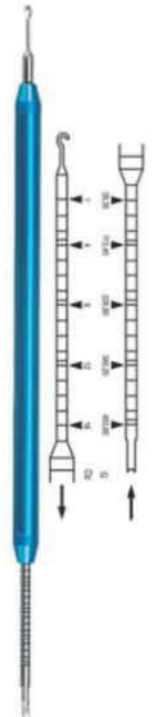

MD-2116
Dynamometer

- Инструменты для имплантологии
- Implantologie
- Implantologie
- Инструменти для імплантології
- Implantologia
- زراعة الأسنان

BLACK TITANIUM COLOUR COATED INSTRUMENTS

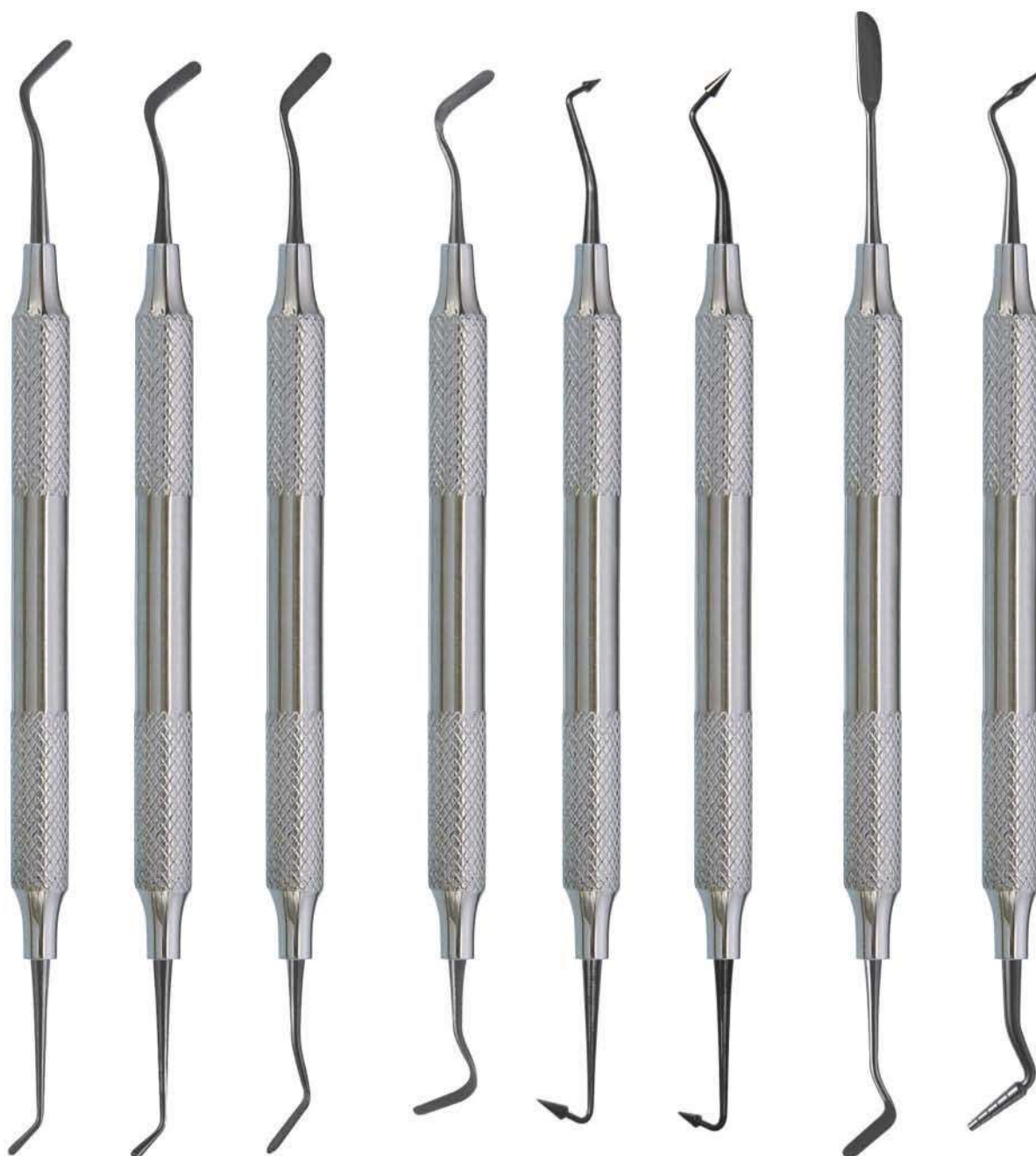

MD-2117
#1

MD-2118
#2

MD-2119
#3
Extra-Flex

MD-2120
#4
Extra-Flex

MD-2121
#5
Flexi-Thin

MD-2122
#6
Flexi-Thin

MD-2123
AB1
Boghosian

MD-2124
AB2
Boghosian

IMPLANTOLOGY



- Инструменты для имплантологии
- Implantologie
- Implantologie
- Инструменти для імплантології
- Implantoloia
- زراعة الأسنان

BLACK TITANIUM COLOUR COATED INSTRUMENTS

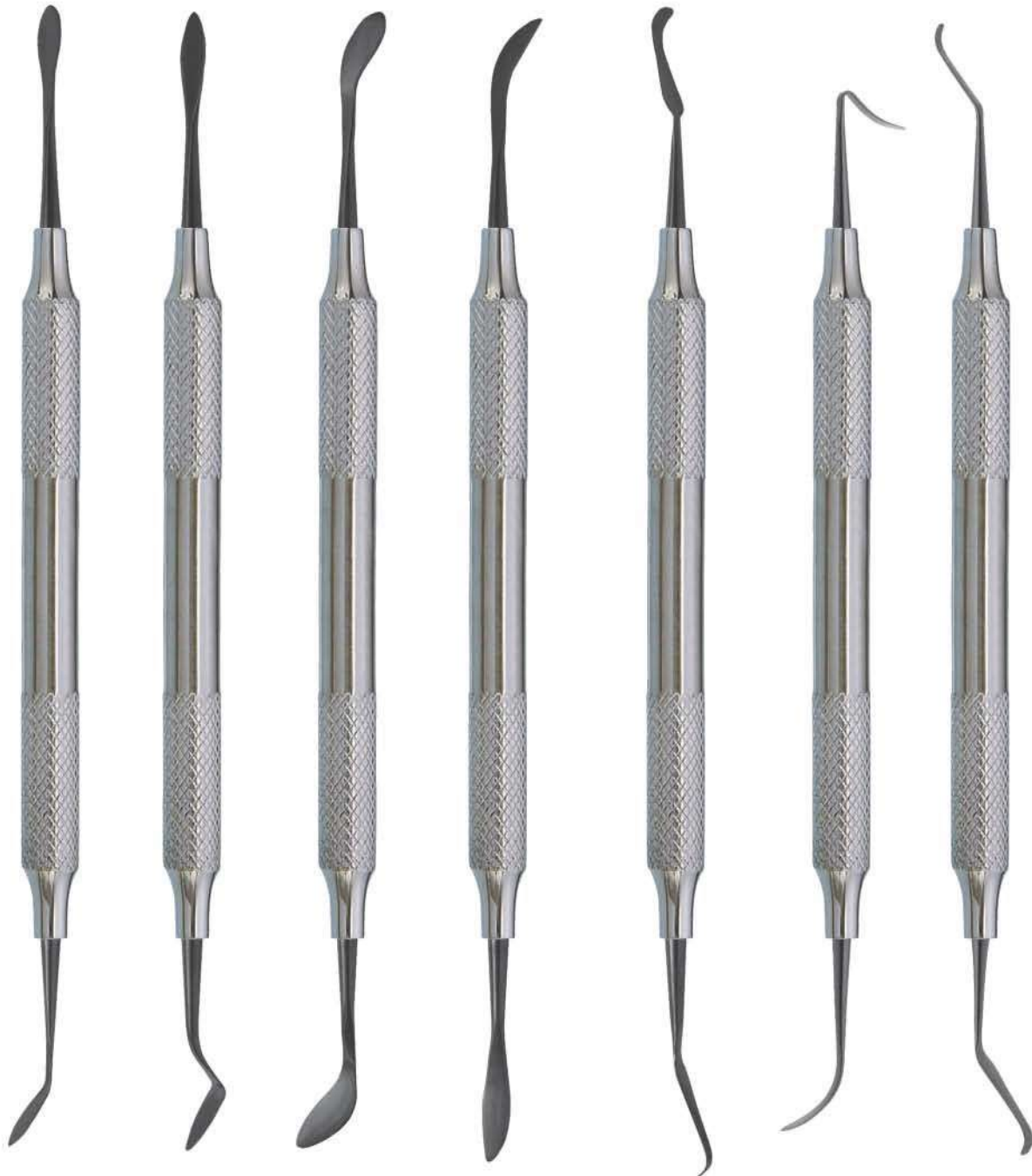

MD-2125
A
Cosmetic
Contouring

MD-2126
B
Cosmetic
Contouring

MD-2127
C
Cosmetic
Contouring

MD-2128
D
Cosmetic
Contouring

MD-2129
F
Cosmetic
Contouring

MD-2130
Marginal Ridge
& Embrasure
Shaping Instrument

MD-2131
Occlusal
Anatomy
Instrument

- Инструменты для имплантологии
- Implantologie
- Implantologie
- Инструменти для імплантології
- Implantologia
- زراعة الأسنان

BLACK TITANIUM COLOUR COATED INSTRUMENTS

BURNISHERS

FREEDMAN BURNISHERS



MD-2132
21B



MD-2133
27/29



MD-2134
2
Ladmore



MD-2135
3
Ladmore



MD-2136
Freedman
"Duckhead"



MD-2137
Freedman
Small Contact
Forming



MD-2138
Freedman
Large Contact
Forming



MD-2139
Small/
Medium Ball
Burnisher

IMPLANTOLOGY



- Инструменты для имплантологии
- Implantologie
- Implantologie
- Инструменти для імплантології
- Implantologia
- زراعة الأسنان

SINUS LIFT INSTRUMENTS HOLLOW HANDLE 9.5MM LENGTH 170MM

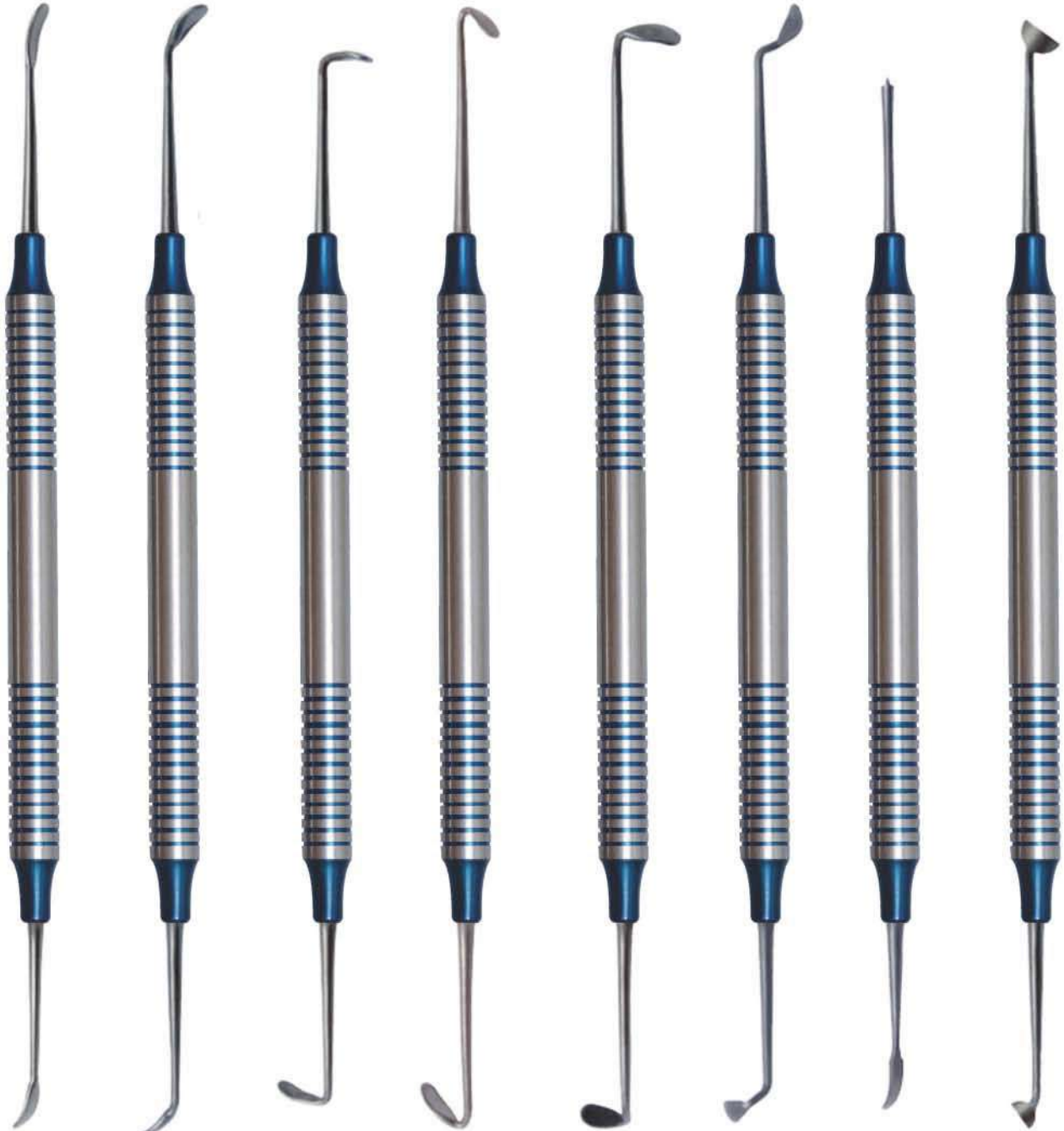

MD-2140
Sinuslift 1

MD-2141
Sinuslift 2

MD-2142
Sinuslift 3

MD-2143
Sinuslift 4

MD-2144
Sinuslift 5

MD-2145
Sinuslift 6

MD-2146
Membrane
3Positioning 1

MD-2147
Condenser 1

- Инструменты для имплантологии
- Implantologie
- Implantologie
- Инструменти для імплантології
- Implantologia
- زراعة الأسنان

Sinus Lift Instrument,
Flexible Sinus Lift instruments
reduce the risk of perforation of the
"Schneider's membrane"



MD-2148 Fig. 1 MD-2149 Fig. 2 MD-2150 Fig. 3

Sinus Lift Elevator,
10 mm Straight grip
Length 175 mm, Sinus lift elevators, dull,
for gentle peeling and lifting the
Schneider membrane



MD-2151 Fig. 1 MD-2152 Fig. 2 MD-2153 Fig. 3

Sinus lift instrument
10 mm Straight grip Length 180 mm,
Buser (B1, B2, B3) raspatories,
quality medical stainless steel,
corrosion-resistant



MD-2154 B01 MD-2155 B02 MD-2156 B03

IMPLANTOLOGY



- Инструменты для имплантологии
- Implantologie
- Implantologie
- Инструменти для імплантології
- Implantoloia
- زراعة الأسنان

Sinus lift instrument 10 mm Straight grip Sinus lift elevators, blunt or sharply curved (H01, H02, K03, K04, K78, K77)

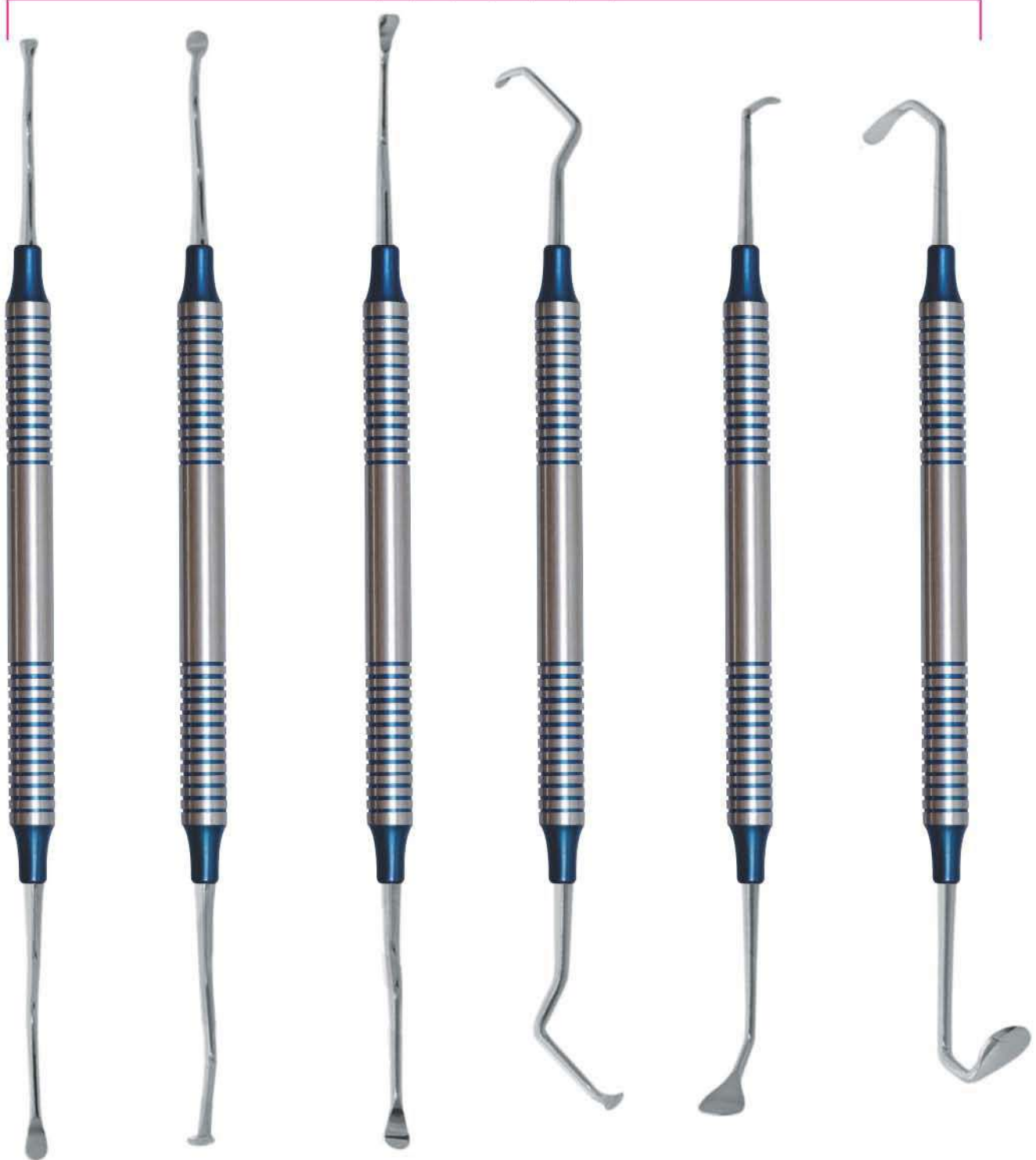

MD-2157
Sinus lift instrument
H01

MD-2158
Sinus lift instrument
H02

MD-2159
Sinus lift instrument
K03

MD-2160
Sinus lift instrument
K04

MD-2161
Sinus lift instrument
K78

MD-2162
Sinus lift instrument
K77

- Инструменты для имплантологии
 - Implantologie
 - Implantologie
- Інструменти для імплантології
 - Implantologia
 - زراعة الأسنان

Composite Filling Instruments Set of 6 Pcs



MD-2163



MD-2164



MD-2165



MD-2166



MD-2167



MD-2168

COMPOSITE INSTRUMENTS USE:

A composite (tooth colored) filling is used to repair a tooth that is affected by decay, cracks, fractures, etc. The decayed or affected portion of the tooth will be removed and then filled with a composite filling.

There are many types of filling materials available, each with their own advantages and disadvantages. You and your dentist can discuss the best options for restoring your teeth. Composite fillings, along with silver amalgam fillings, are the most widely used today. Because composite fillings are tooth colored, they can be closely matched to the color of existing teeth, and are more aesthetically suited for use in front teeth or the more visible areas of the teeth.

As with most dental restorations, composite fillings are not permanent and may someday have to be replaced. They are very durable, and will last many years, giving you a long lasting, beautiful smile.

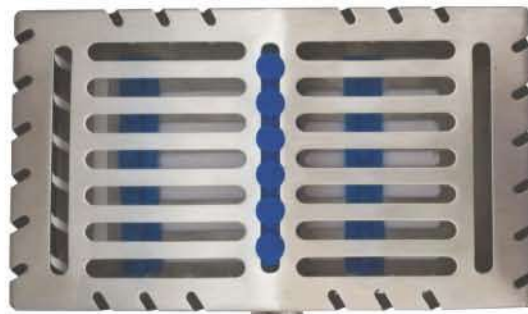
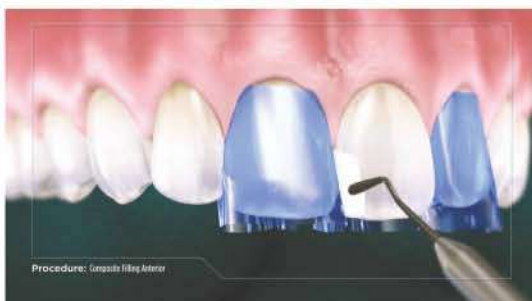

MD-2169

IMPLANTOLOGY



- Инструменты для имплантологии
- Implantologie
- Implantologie
- Инструменти для імплантології
- Implantoloia
- زراعة الأسنان

Set of 5 Composite Gold Tip Instruments
MD-2170



Set of 4 Composite Blue Tip Instruments
MD-2171



Set of 3 Composite Blue Tip Instruments
MD-2172



Set of 2 Composite Blue Tip Instruments
MD-2173



MD-2174 Periosteal Elevators Molt # 9

MD-2175 Endodontic explorer DG # 16

- Инструменты для имплантологии
- Implantologie
- Implantologie
- Инструменти для імплантології
- Implantologia
- زراعة الأسنان

VISTA TUNNELING INSTRUMENTS SET



MD-2176



MD-2177



MD-2178



MD-2179



MD-2180



MD-2181



MD-2182



IMPLANTOLOGY



- Инструменты для имплантологии
- Implantologie
- Implantologie

- Інструменти для імплантології
- Implantologia
- زراعة الأسنان



MD-2183

used for elevation of sinus membrane



MD-2184

used for elevation of sinus membrane



MD-2185

Cobra in / out (2-4-5-6-8-10mm)



MD-2186

Cobra 3.5mm



MD-2187

sinus 4.8 / 5.8 (2-4-5-6-8-10mm)



MD-2188

sinus 2.8 / 3.8 (2-4-5-6-8-10mm)



MD-2189

Bone Graft 3.8SP / 2.8mm (2-4-5-6-8-10mm)



MD-2190

Cobra in / out (2-4-5-6-8-10mm)



MD-2191

Cobra 3.5mm



MD-2192

Gold Color Set Dental Oral Implantology Sinus Set of 10 Pcs with cassette

- Инструменты для имплантологии
- Implantologie
- Implantologie
- Инструменти для імплантології
- Implantologia
- زراعة الأسنان



MD-2193
Sinus Lift elevator 1



MD-2194
Sinus Lift elevator 2



MD-2195
Sinus Lift elevator 3



MD-2196
Sinus Lift elevator 4



MD-2197
Sinus Lift elevator 5



MD-2198
Sinus Lift elevator 6



MD-2199
Sinus Lift Elevators Set of 7 Pcs
with cassette

IMPLANTOLOGY



- Инструменты для имплантологии
- Implantologie
- Implantologie
- Инструменти для імплантології
- Implantologia
- زراعة الأسنان

Sinus Left Elevator Set of 10 Pcs

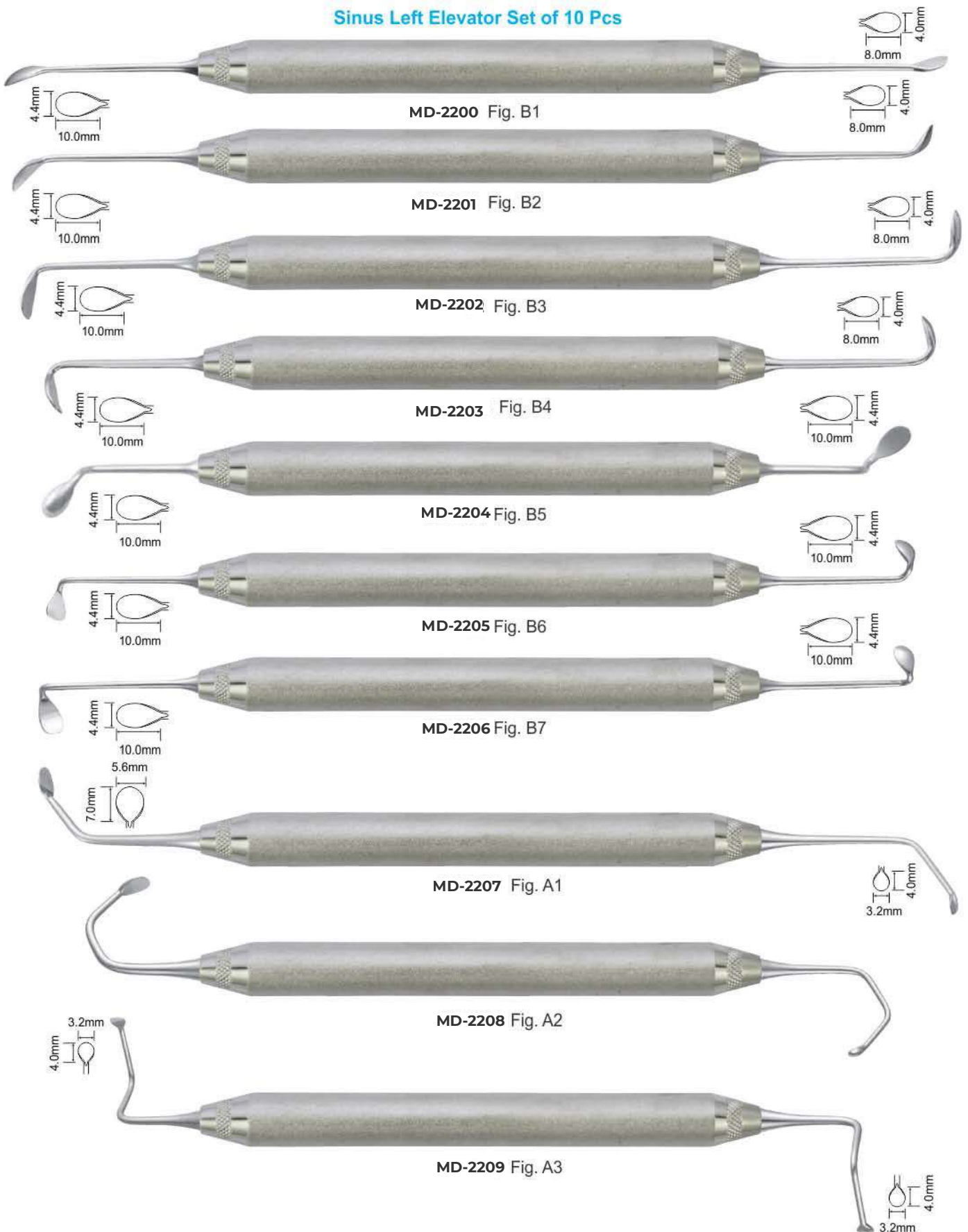

- Инструменты для имплантологии
 - Implantologie
 - Implantologie
- Инструменти для імплантології
 - Implantologia
 - زراعة الأسنان

Blue Titanium Coated Bone Grafting Instruments



MD-2210

Bone Graft 1.0 / 1.7 mm Titanium 8. 11. 13. 15. 18 mm



MD-2211

Bone Graft 1.0 / 2.0 mm Titanium 8. 11. 13. 15. 18 mm



MD-2212

Bone Graft 2.4 / 2.7 mm Titanium 8. 11. 13. 15. 18 mm



MD-2213

Bone Graft 3.3 / 4.0 mm Titanium 8. 11. 13. 15. 18 mm



MD-2214

Bone Graft 3.3 / 4.0 mm Titanium Coated Tips



MD-2215

Bone Graft / Carrier Titanium 8. 11. 13. 15. 18 mm

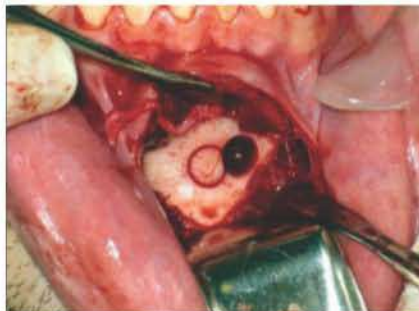

MF-2216

Blue Titanium Coated Bone Grafting Instruments Set of 7 Pcs with cassette

- Инструменты для имплантологии
- Implantologie
- Implantologie

- Инструменти для імплантології
- Implantoloia
- زراعة الأسنان



MD-2227
Fig. 1



With curette the sinus membrane is further detached over a broad area in the inner region, especially along the roof of the palate.



MD-2218
Fig. 2



MD-2219
Fig. 3



MD-2220
Fig. 4



MD-2221
Fig. 5



MD-2222
Fig. 6



MD-2223



MD-2224



MD-2225



MD-2226



MD-2227

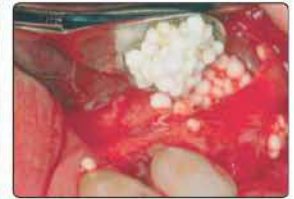

Flexible Sinus-Lift Curettes – for an optimum sensitivity during the direct lift procedure

The perforation of the Schneiderian membrane is a complication that often occurs during a maxillary sinus floor augmentation procedure. The Sinus-Lift Instruments increase the sensitivity by blunt and flexible working tips with "Swing-Effect". Because of their special shapes and the characteristic of the stainless steel between the handle and the active part, light pressure is cushioned and gives the operator a direct and sensitive response. At the same time the risk to perforate the Schneiderian membrane is reduced to a minimum. Already at the development the focus was a practicable handling. Because of varying angulations and shapes of the active parts also in difficult areas they are easy to navigate also in difficult areas. The line of curettes consists of six different figures for every situation. They are complemented by spoon and condenser to place the bone graft.



The "Schneider's Membrane" of the sinus can be detached with curette by 1–2mm along the total cortical bone.



Curette is particularly useful in the lower part for detaching the membrane further. The same goes for the caudal area, especially when the membrane is 4–5 mm above the base of the maxillary sinus and the maxillary sinus is built up with granular material.



Curette makes it possible to lift the membrane further in mesial region. One working tip is especially designed for the right maxillary sinus and the other for the left maxillary sinus.



With curette the sinus membrane is further elevated in the upper and posterior part of the maxillary sinus wall.

- Инструменты для имплантологии
- Implantologie
- Implantologie

- Инструменти для імплантології
- Implantologia
- زراعة الأسنان

IMPLANT SINUS LIFT INSTRUMENTS HOLLOW HANDLE 9.5MM LENGTH 170MM

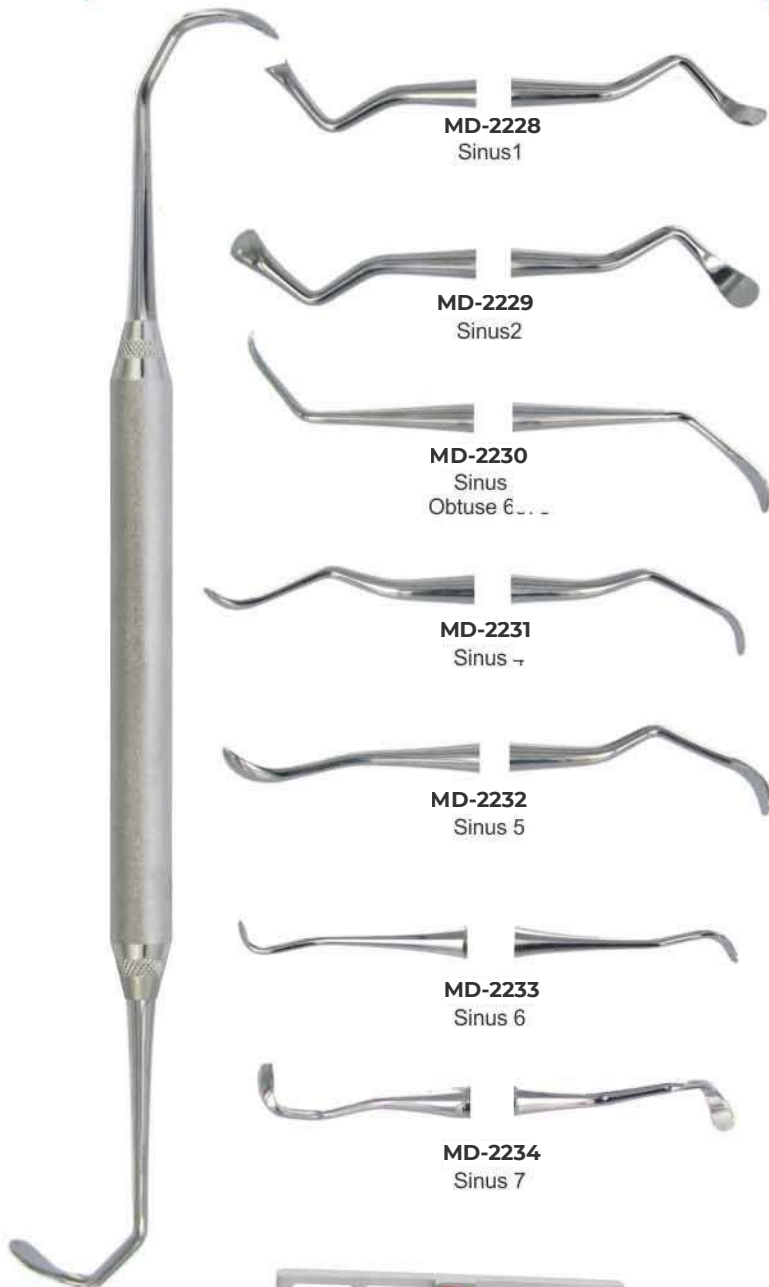

MD-2228
Sinus1

MD-2229
Sinus2

MD-2230
Sinus
Obtuse 6577

MD-2231
Sinus 4

MD-2232
Sinus 5

MD-2233
Sinus 6

MD-2234
Sinus 7

MD-2242
Acute 6577



9 Pcs of Set
MD-2244

SINUS LIFT INSTRUMENTS HOLLOW HANDLE 9.5MM LENGTH 170MM



MD-2235
Sinuslift 2

MD-2236
Sinuslift 3

MD-2237
Sinuslift 4

MD-2238
Sinus1

MD-2239
Sinus1

MD-2240
Membrane
3Positioning 1

MD-2241
Condenser 1

MD-2243
Sinuslift 1



9 Pcs of Set
MD-2245

IMPLANTOLOGY



- Инструменты для имплантологии
- Implantologie
- Implantologie

- Инструменти для имплантології
- Implantologia
- زراعة الأسنان

IMPLANT SINUS LIFT INSTRUMENTS PERIODONTAL SURGERY SURGICAL CHISELS KRAMER NEVINS SINUS LIFT

SURGICAL CHISELS



MD-2246
TG



MD-2247 SOLT3/4



MD-2248 TGO



MD-2249 OCH3



MD-2250 OCH4



MD-2251 FEDI1



MD-2252 FEDI2



MD-2253 FEDI3



3.5mm

MD-2254 13K/TG

3mm



3.5mm

MD-2255

13K/TG Titanium

3mm



3.5mm

MD-2256 13K/TG

4.5mm



3.5mm

MD-2257

13KL/R Titanium

4.5mm



4mm

MD-2258 13KL 4/6mm

Titanium Available

6mm



MD-2259
Cassette For Instruments

- Инструменты для имплантологии
- Implantologie
- Implantologie
- Инструменти для імплантології
- Implantologia
- زراعة الأسنان

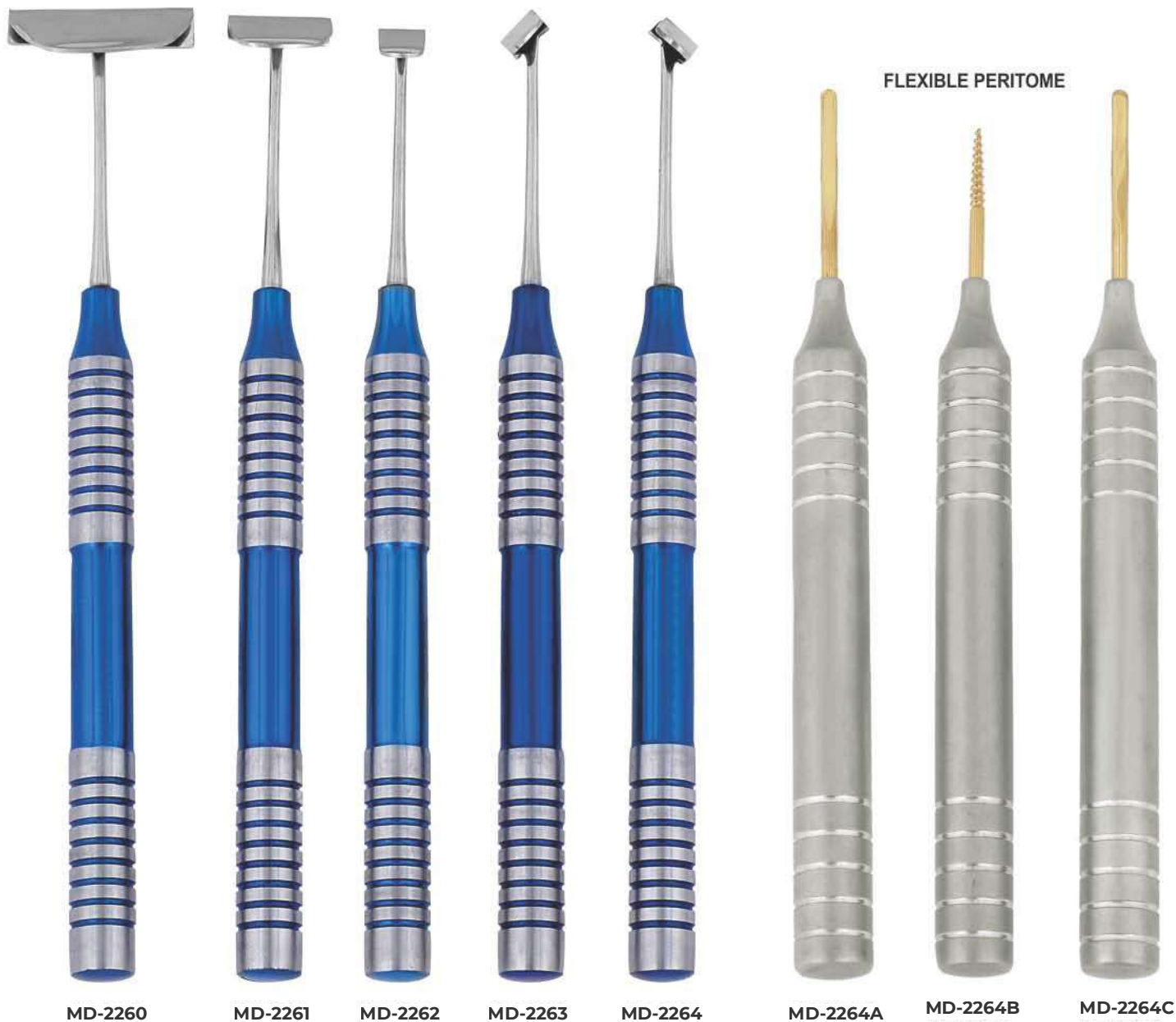

Soft Brushing Kit Set of 6 Pcs



IMPLANTOLOGY



- Инструменты для имплантологии
- Implantologie
- Implantologie
- Инструменти для імплантології
- Implantologia
- زراعة الأسنان

SINUS ELEVATOR & MEMBRANE LIFT TIPS



MD-2265
Membrane Detach Elevator



MD-2266
Membrane Elevator



MD-2267
Membrane Elevator



MD-2268
Membrane Elevator



MD-2269
Membrane Elevator



MD-2270
Bone Graft Packer



MD-2270A Pt2 Titanium
A/V Regular



MD-2270B Pt1 Titanium
A/V Regular



MD-2270C Pt3 Titanium Angel S/E



MD-2270D Pt4 Titanium STR S/E



MD-2270E Pt5 Titanium TG CVD S/E



MD-2271
Sinus Left Elevator & Membrane Lift Tips 3
set of 7 Pcs

- Инструменты для имплантологии
- Implantologie
- Implantologie
- Инструменти для імплантології
- Implantologia
- زراعة الأسنان

MIXING SPATULA WITH SHOVEL



MD-2272
Bone Carrier
Titanium



MD-2273
Raspator, Prichard
Length 180 mm,
10 mm hollow handle,
double-ended
10.5 mm | 4.5 mm,



MD-2274
Raspator, Prichard
Length 180 mm,
10 mm hollow handle,
double ended



MD-2275
Raspator, Prichard
Length 180 mm,
10 mm hollow handle,
double-ended
10.5 mm | 4.5 mm,



MD-2276
Mixing Spatula
with shovel
17cm



MD-2277
Mixing Spatula
with shovel
18.5cm



MD-2278
Graft Material Spoon
Concave Tip For
Larger Grafts

IMPLANTOLOGY



- Инструменты для имплантологии
 - Implantologie
 - Implantologie
- Инструменти для имплантології
 - Implantologia
 - زراعة الأسنان

BONE GRAFTING INSTRUMENTS COMPACTOR /TAMPERS

Product offering includes instruments for harvesting, mixing and compacting bone Provides clinicians with the proper instrumentation for bone grafting procedures Weighted bone basin Prevents tipping and spilling of bone and other materials during mixing



MD-2279
Graft Packer, Concave Tips DE 4/6mm



MD-2280
Bone Spoon/ Packer DE 3mm



MD-2281
Blade and pusher Length 180 mm, for straight or angled, blade: 15 x 5 mm, pusher: 4 mm diameter Straight



MD-2282
Blade and pusher Length 180 mm, for straight or angled, blade: 15 x 5 mm, pusher: 4 mm diameter angular



MD-2283
Spoon and pusher Length 180 mm, for angled spoon: 10 x 5 mm, pusher: diameter 3 mm



MD-2284
Graft Packer, Smooth Tips DE 5/8mm



MD-2285
Graft Packer, Serrated Tips DE 3/4mm



MD-2286
Graft Packer, Serrated Tips DE 6/8mm



MD-2287
Titanium graft packer/placement site depth gauge 3.3mm & 4.0mm Diameter tips Marked at 8, 11, 13, 15 & 18mm



MD-2288
Tamper Length 170 mm, for bone material, double-ended, diameter 3.2 mm (2-4-6-8-10) and diameter 2.5mm (2-4-6-8-10)

- Инструменты для имплантологии
- Implantologie
- Implantologie
- Инструменти для імплантології
- Implantologia
- زراعة الأسنان

SPOON AND PUSHER (TRINOVO)

Trinovo handle, different workers, for bone material, high-grade medical stainless steel, corrosion-resistant

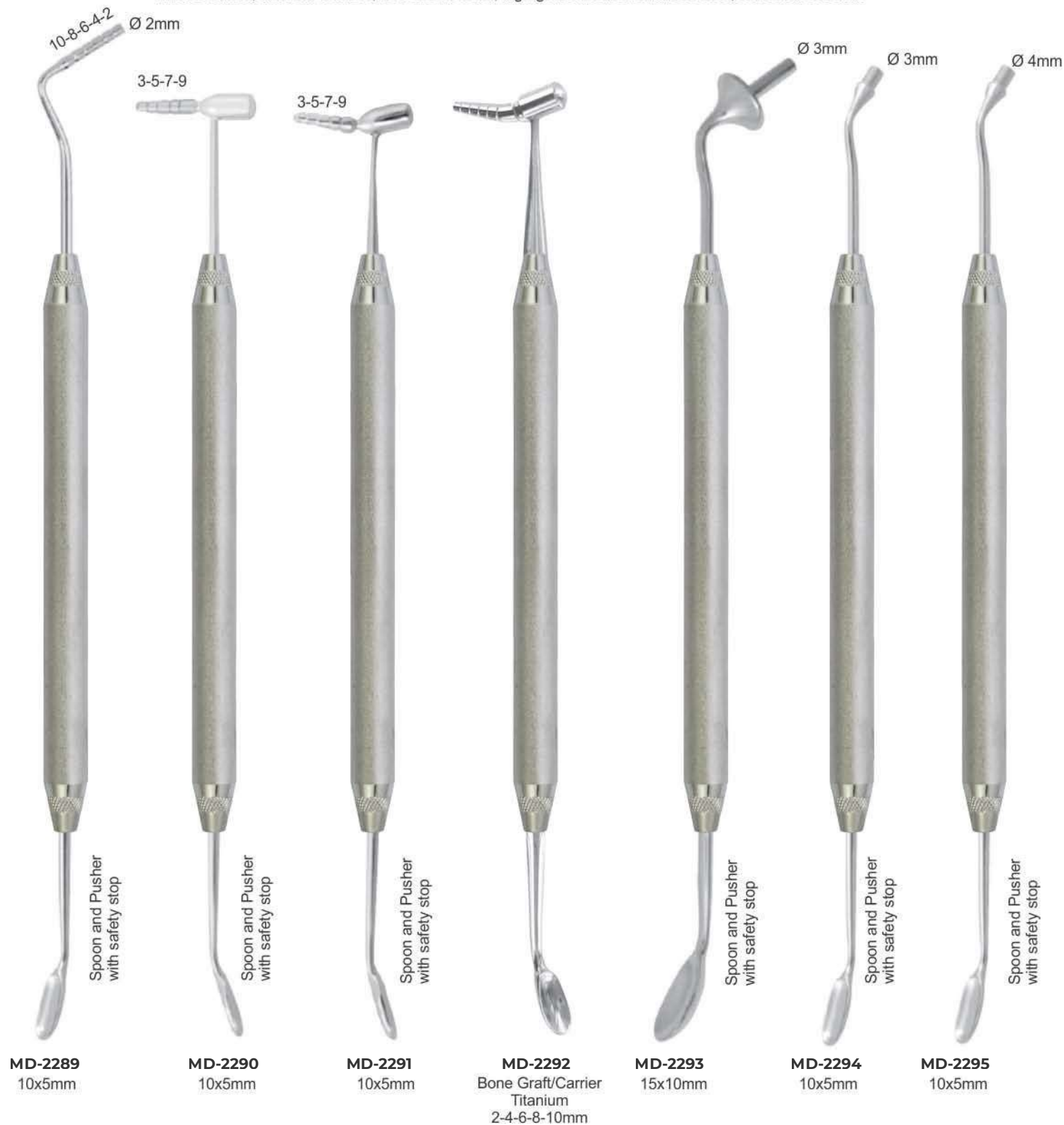

IMPLANTOLOGY



- Инструменты для имплантологии
- Implantologie
- Implantologie

- Инструменти для імплантології
- Implantologia
- زراعة الأسنان

Hollow Handle 10mm Length 170mm



- Инструменты для имплантологии
- Implantologie
- Implantologie
- Инструменти для імплантології
- Implantologia
- زراعة الأسنان

TISSUE MEMBRANE FORCEPS



MD-2305
Tissue Graft Forcep
Serrated Teeth



MD-2306
Self Locking
Grooved



MD-2307
Tissue Graft Forcep
Serrated Teeth



MD-2308
Titanium
Locking Plier



MD-2309
TC Gripper Carbide
Tipped Tissue Forceps
Serrated Carbide Tips
14.5cm



MD-2310
Adson Carbide
Tipped Tissue Forceps
Serrated Carbide Tips
12cm



MD-2311
Micor Adson 1x2
Tissue Forcep 12.1cm
1x2 Teeth - 0.5mm Tips



MD-2312
Adson 7x7
Tissue Forceps
7x7 Teeth 12cm



MD-2313
Adson 7x7 Curved
Tissue Forceps
7x7 Teeth 12cm



MD-2314
Suture Pliers
Suture Forceps with
1.6mm Ring Tip



MD-2315
Debakey Atraumatic
Tissue Forceps Straight
Serrated Teeth
16cm



MD-2316
Debakey Atraumatic
Tissue Forceps Curved
Serrated Teeth
16cm

IMPLANTOLOGY



- Инструменты для имплантологии
- Implantologie
- Implantologia
- زراعة الأسنان
- Инструменти для имплантології
- Implantologia

TISSUE MEMBRANE FORCEPS



MD-2317
Russian Long
Tissue Forceps
Serrated Tip
20cm



MD-2318
Russian
Tissue Forceps
Serrated Tip
15cm



MD-2319
Tissue Punch Forceps
To Remove Tissue
After Using Punch



MD-2320
13.5 cm
narrow



MD-2321
10.5 cm
Membrane tweezers KUEHNE



MD-2322
13.5 cm
wide



MD-2323
Pin-Tweezers
with or without lock,
length 15 cm,
with lock



MD-2324
without lock



MD-2325
Haltepinzette with lock
15,5 cm, for pins, towards
the tips, etc



MD-2326
Carry Forceps
15cm



MD-2327
Carry Forceps
15cm



MD-2328
Carry Forceps
15cm

- Инструменты для имплантологии
- Implantologie
- Implantologie
- Инструменти для імплантології
- Implantologia
- زراعة الأسنان

OSTEOTOME CONVEXES / CONCAVE / CONIQUES

CONVEXES



MD-2329
SET OF 5 PIECES

CONCAVES

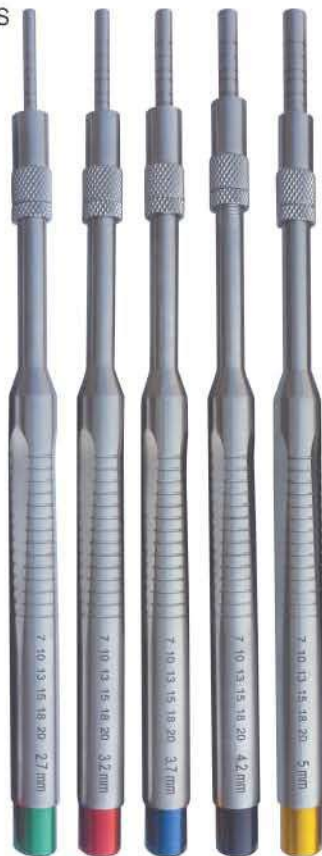

MD-2330
SET OF 5 PIECES

CONIQUES



MD-2331
SET OF 5 PIECES

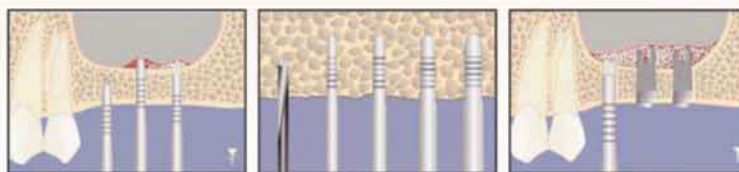

	CONVEXES STRAIGHT	MD-2329	2,7 Ømm	3,2 Ømm	3,7 Ømm	4,2 Ømm	5 Ømm
	CONCAVES STRAIGHT	MD-2330	2,7 Ømm	3,2 Ømm	3,7 Ømm	4,2 Ømm	5 Ømm
	CONIQUES STRAIGHT	MD-2331	2,7 Ømm	3,2 Ømm	3,7 Ømm	4,2 Ømm	5 Ømm

IMPLANTOLOGY



- Инструменты для имплантологии
- Implantologie
- Implantsologie
- زراعة الأسنان

OSTEOTOME CONVEXES / CONCAVE / CONIQUES

CONVEXES



MD-2332
SET OF 5 PIECES

CONCAVES



MD-2333
SET OF 5 PIECES

CONIQUES



DE-2334
SET OF 5 PIECES

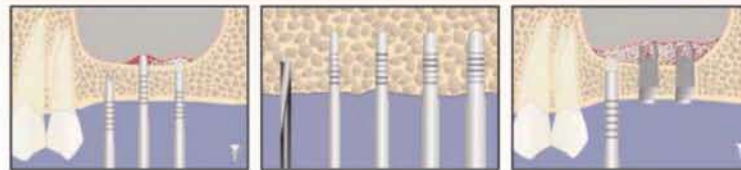

	CONVEXES CURVED	MD-2332	2,7 Ømm	3,2 Ømm	3,7 Ømm	4,2 Ømm	5 Ømm
	CONCAVES CURVED	MD-2333	2,7 Ømm	3,2 Ømm	3,7 Ømm	4,2 Ømm	5 Ømm
	CONIQUES CURVED	MD-2334	2,7 Ømm	3,2 Ømm	3,7 Ømm	4,2 Ømm	5 Ømm

- Инструменты для имплантологии
- Implantologie
- Implantologie
- Инструменти для імплантології
- Implantologia
- زراعة الأسنان

BONE SCRAPER STRAIGHT & CURVED



MD-2335
Bone Scraper
Straight

MD-2336
Bone Scraper
Curved

TISSUE PUNCH STRAIGHT & CURVED



Tissue Punch
Straight



Tissue Punch
Curved

●
MD-2337
2.0mm

●
MD-2338
4.0mm

●
MD-2339
5.0mm

●
MD-2340
6.0mm

●
MD-2341
7.0mm

●
MD-2342
8.0mm

●
MD-2343
2.0mm

●
MD-2344
4.0mm

●
MD-2345
5.0mm

●
MD-2346
6.0mm

●
MD-2347
7.0mm

●
MD-2348
8.0mm

Ø4.0 Ø5.0 Ø6.0 Ø7.0



MD-2349
Tissue Punch with pin
Set of Four Pieces



MD-2350
Tissue Punch
Set of Five Pieces



MD-2351
Tissue Punch
Set of Five Pieces

IMPLANTOLOGY



- Инструменты для имплантологии
- Имплантология
- Implants
- Implants
- زراعة الأسنان
- Инструменти для имплантології
- Implants

BONE MILL BONE WELL

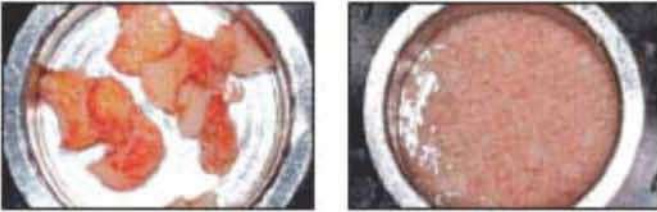

- Инструменты для имплантологии
 - Implantologie
 - Implantologie
- Інструменти для імплантології
 - Implantologia
 - زراعة الأسنان

TREPHINE

Burs with depth markings are suited for precise and simple transplantation of cylindrical bone grafts as well as for all other bone-extraction tasks.



MD-2367
Trepine Drill
Set of Eight Pieces



MD-2368
Trepine Drill
Set of Eight Pieces

BONE INJECTORS, COLLECTORS & SUCTION TUBE

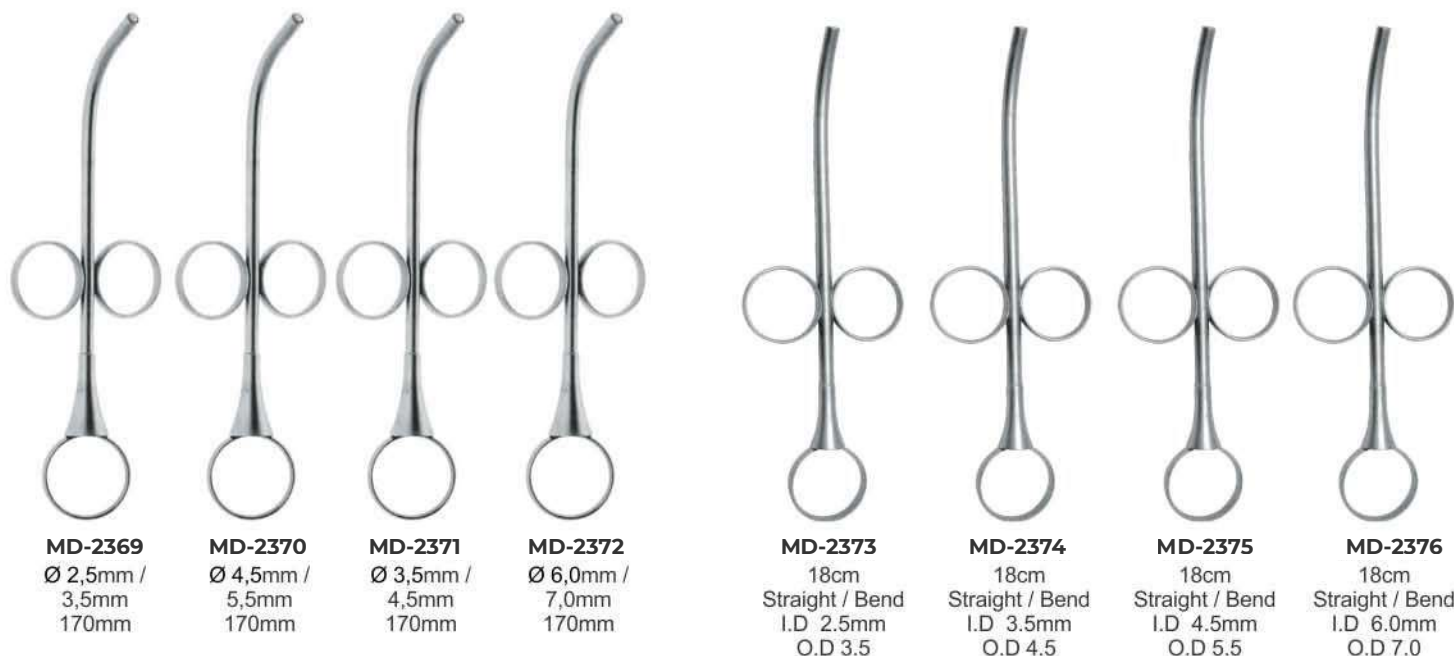

IMPLANTOLOGY



- Инструменты для имплантологии
- Implantologie
- Implantologie
- Инструменти для имплантології
- Implantologia
- زراعة الأسنان

BONE EXPANDER SCREW & SURGICAL KITS



Ø2.0mm Ø2.5mm Ø2.8mm

DE-2377 Short Implant Drills



Ø3.2mm Ø3.65mm Ø4.2mm Ø5.2mm

MD-2378 Long Implant Drills



MD-2379

Bone Universal Kit

Drill: 2mm, 2.8mm, 3.2mm, 3.65mm, 4.2mm, 4.5mm, 4.8mm, 5.2mm
 Trephines Bit: 3.0mm, 4.0mm, 5.0mm, 6.0mm, 7.0mm, 8.0mm, 9.0mm, 10mm.
 Driver: 2.5mm, 2.5mm Hand Pcs, 1.25mm, 1.25mm Hand Pcs
 Short Driver 2.5mm, Long Driver 2.5mm
 1.25mm, Short Hex Driver Hand Pcs
 1.25mm, Long Hex Driver Hand Pcs, Torque Wrench 4.0mm



MD-2380

Bone Expander Kit

Expander: 2.6mm, 3.0mm, 3.4mm, 3.8mm, 4.3mm
 Ratchet Driver, Parallel Pin
 Pilot Drill, Drill 1.4mm, Drill Driver 4mm
 Hand Driver 4mm, Ratchet 4.0mm



MD-2381

Bone Universal Kit

Drill: 2mm, 2.8mm, 3.2mm, 3.65mm,
 4.2mm, 4.5mm, 4.8mm, 5.2mm
 Trephines Bit:
 3.0mm, 4.0mm, 5.0mm, 6.0mm,
 7.0mm, 8.0mm, 9.0mm, 10mm.

Bone Compression:

2mm, 3.3mm, 2.8mm, 4.2mm, 3mm, 3.5mm
 Driver:
 2.5mm, 2.5mm Hand Pcs
 1.25mm, 1.25mm Hand Pcs
 Short Driver 2.5mm
 Long Driver 2.5mm
 1.25mm, Short Hex Driver Hand Pcs
 1.25mm, Long Hex Driver Hand Pcs
 Torque Wrench 6.35mm 1 Pcs



MD-2382

Conical Drills: 20 Pcs

Tissue Punches:
 3.0mm, 3.50mm, 4.0mm, 4.5mm,
 5.0mm, 6.0mm, 6.50mm
 Bone Expander:
 1.6/3.8mm, 1.9/3.0mm, 2.1/3.6mm,
 2.6/3.8mm, 2.9/4.3mm
 Drill Adapter: 1 Pcs
 1.25mm, 2.50mm Hex Driver Hand Pcs

Pilot Drill: 1.6mm

Drill Bit: 1.4mm, 1.6mm, 1.8mm, 2.0mm, 2.2mm
 Ratchet Driver: 4mm/6.35, 1.25/2.50
 Rimer: 3.2/4.7mm, 3.7/4.7mm
 Parallel Pin: 4.5mm, 2.5mm
 Double step Drill: 2.4/2.8mm
 Depth Gauge: 1 Pcs
 Torque Wrench 6.35mm Universal: 1 Pcs

- Инструменты для имплантологии
 - Implantologie
 - Implantologie
- Инструменти для імплантології
 - Implantologia
 - زراعة الأسنان

KEYS FOR IMPLANT SCREW



MD-2383



MD-2384



MD-2385



MD-2386

TORQUE WRENCH & RATCHET



MD-2387 Star Torque Wrench 6.35mm Universal



MD-2393 Star Torque Wrench 6.35mm Universal



MD-2399 Star Ratchet Wrench 6.35mm Universal



MD-2388 Round Torque Wrench 4.0mm Universal



MD-2394 Star Torque Wrench 6.35mm Universal



MD-2400 Star Ratchet Wrench 4.0mm Universal



MD-2389 Hex Driver With 4.0mm Driver



MD-2395 Star Torque Wrench 6.35mm Universal



MD-2401 Round Ratchet Wrench 4.0mm Universal



MD-2390 Star Torque Wrench 6.35mm Universal



MD-2396 Star Torque Wrench 6.35mm Universal



MD-2402 Round Ratchet Wrench 3.35mm Universal



MD-2391 Hex Torque Wrench 4.00mm Universal



MD-2397 Star Ratchet Wrench 6.35mm Universal



MD-2403 Star Ratchet Wrench 4.0mm Universal



MD-2392 Star Torque Wrench 6.35mm Universal



MD-2398 Star Ratchet Wrench 6.35mm Universal



MD-2404 Star Ratchet Wrench 6.35mm Universal

IMPLANTOLOGY



- Инструменты для имплантологии
- Implantologie
- Implantsologie
- Инструменти для імплантології
- Implantologia
- زراعة الأسنان



MD-2405
Suction Cannula Kit
with 3 Needles



Suction Pipe



Suction Needle
1mm



Suction Needle
1.5mm



Suction Needle
2mm



MD-2406
17.5cm

MD-2407
18cm

DE-2408
coarse
Ø 5mm

Suction tubes
to collect
the extracted
bone material
180mm



DE-2409
fine
Ø 9mm



MD-2410
Suction
Tubes
180mm

MD-2411
Suction
Tubes
180mm

MD-2412
Suction
Tubes
180mm



MD-2413
Fig. 6FR
Frazier
15 cm - Ø 2 mm

MD-2414
Ø 3 mm
length 180mm
MD-2415
Ø 4 mm
length 180mm
MD-2416
Ø 5 mm
length 180mm

- Оттисные ложки
 - Porte-empreinte
 - Abdrucklöffel
- Відбиткові ложки
 - Cubetas para impresiones
 - صواني الانطباع

PERFORATED WITH RIM LOCK

Set of 06 Pcs

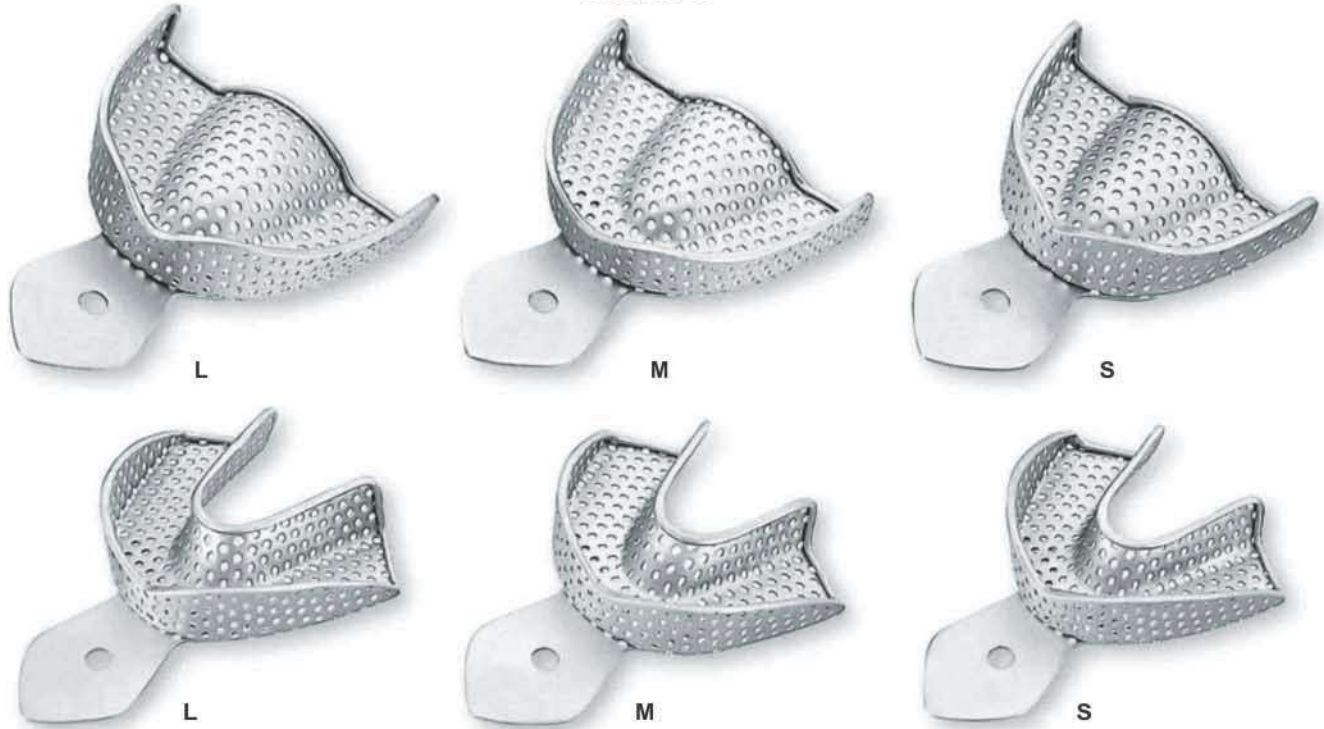

DE-2417 SET OF 06 PCS

Upper: S, M, L
Lower: S, M, L

PERFORATED WITH RIM LOCK

Set of 8 Pcs

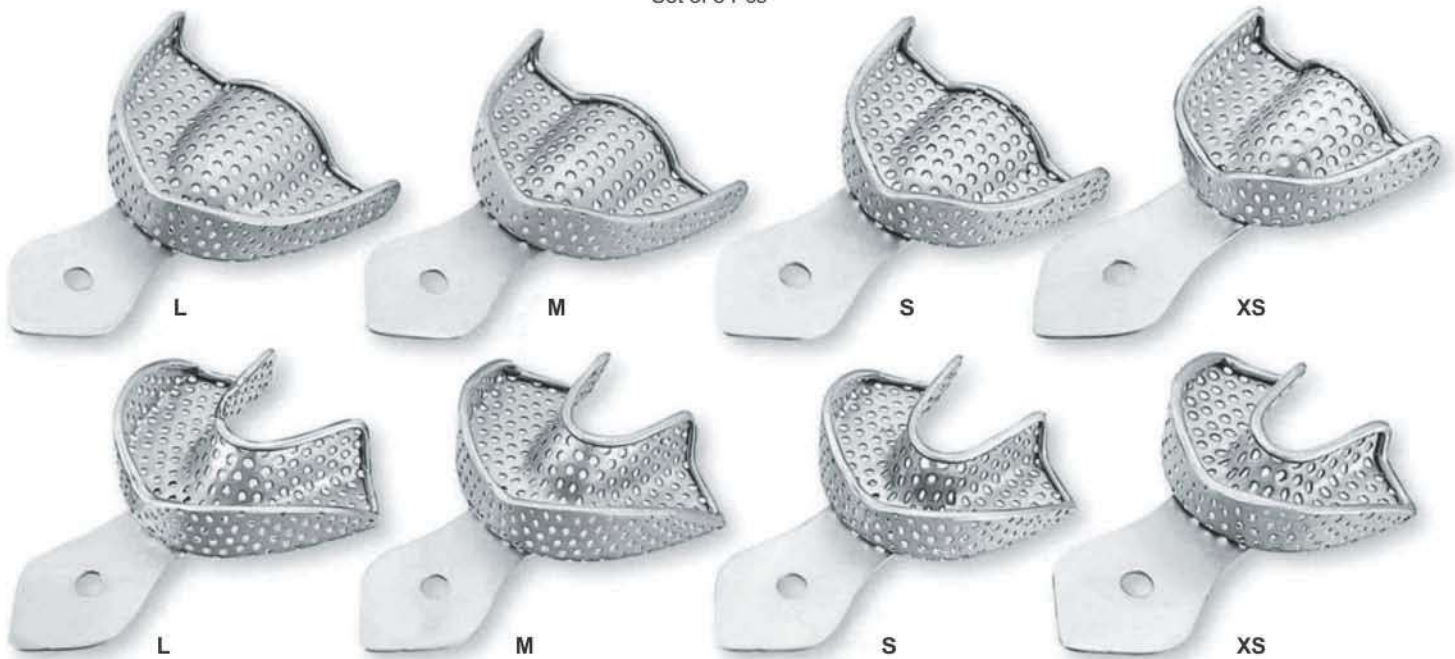

MD-2418 SET OF 08 PCS

Upper: XS, S, M, L
Lower: XS, S, M, L

MD-2419 SET OF 08 PCS

Upper: S, M, L, XL
Lower: S, M, L, XL

MD-2420 SET OF 10 PCS

Upper: XS, S, M, L, XL
Lower: XS, S, M, L, XL

IMPRESSION TRAYS



- Оттисные ложки
 - Porte-empreinte
 - Abdrucklöffel
- Відбиткові ложки
 - Cubetas para impresiones
 - صواني الانطباع

SOLID WITH RIM LOCK

Set of 6 Pcs



MD-2421 SET OF 06 PCS

Upper: S, M, L
Lower: S, M, L

SOLID WITH RIM LOCK

Set of 8 Pcs



MD-2422 SET OF 08 PCS

Upper: XS, S, M, L
Lower: XS, S, M, L

MD-2423 SET OF 08 PCS

Upper: S, M, L, XL
Lower: S, M, L, XL

MD-2424 SET OF 10 PCS

Upper: XS, S, M, L, XL
Lower: XS, S, M, L, XL

- Оттисные ложки
- Porte-empreinte
- Abdrucklöffel
- Відбиткові ложки
- Cubetas para impresiones
- صوتاني الاطباع

PERFORATED FULL DENTURE

Set of 8 Pcs

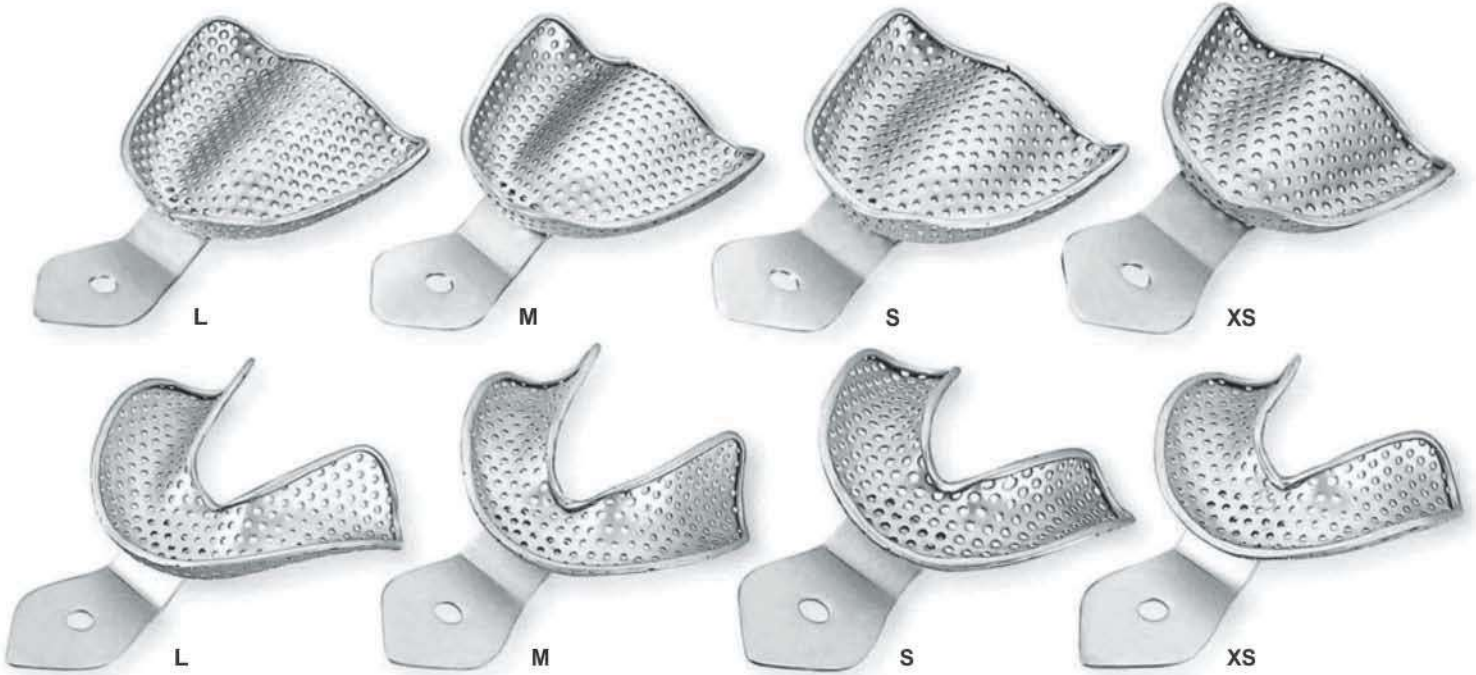

MD-2425 SET OF 08 PCS
Upper: S, M, L, XL
Lower: S, M, L, XL

MD-2426 SET OF 08 PCS
Upper: S, M, L
Lower: S, M, L

SOLID FULL DENTURE

Set of 8 Pcs

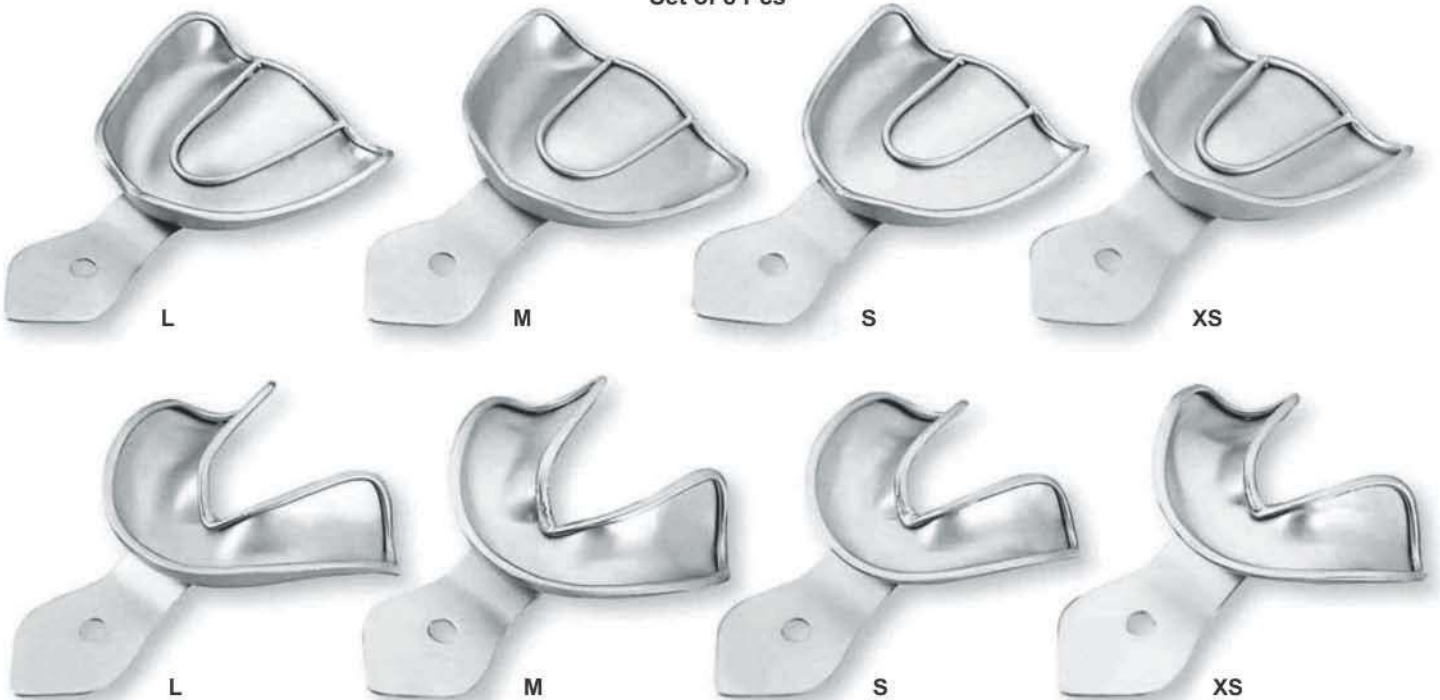

MD-2427 SET OF 08 PCS
Upper: S, M, L, XL
Lower: S, M, L, XL

MD-2428 SET OF 06 PCS
Upper: S, M, L
Lower: S, M, L

IMPRESSION TRAYS



- Оттисные ложки
- Porte-empreinte
- Abdrucklöffel
- Відбиткові ложки
- Cubetas para impresiones
- صواني الانطباع

Perforated Without Rim Lock

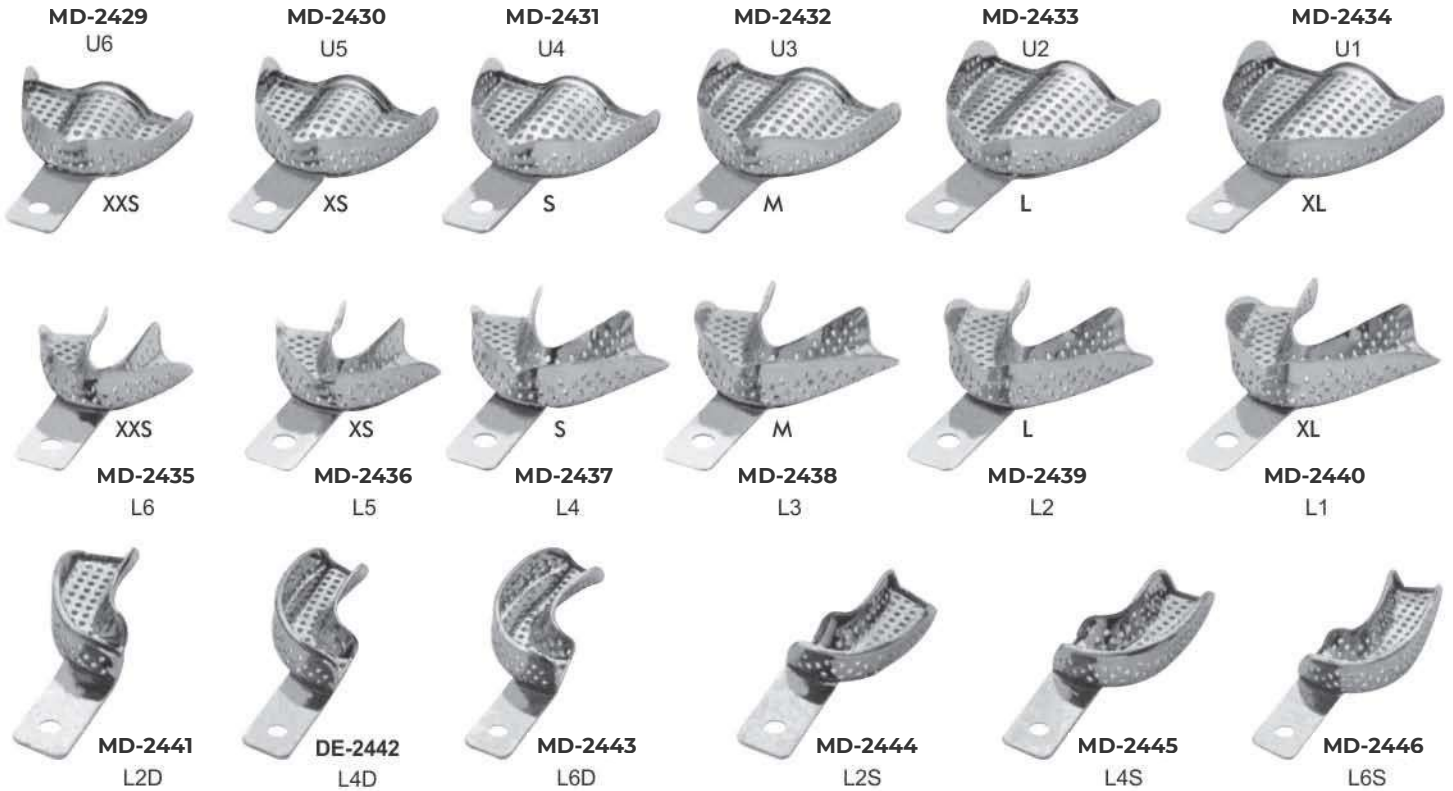

Solid With Rim Lock

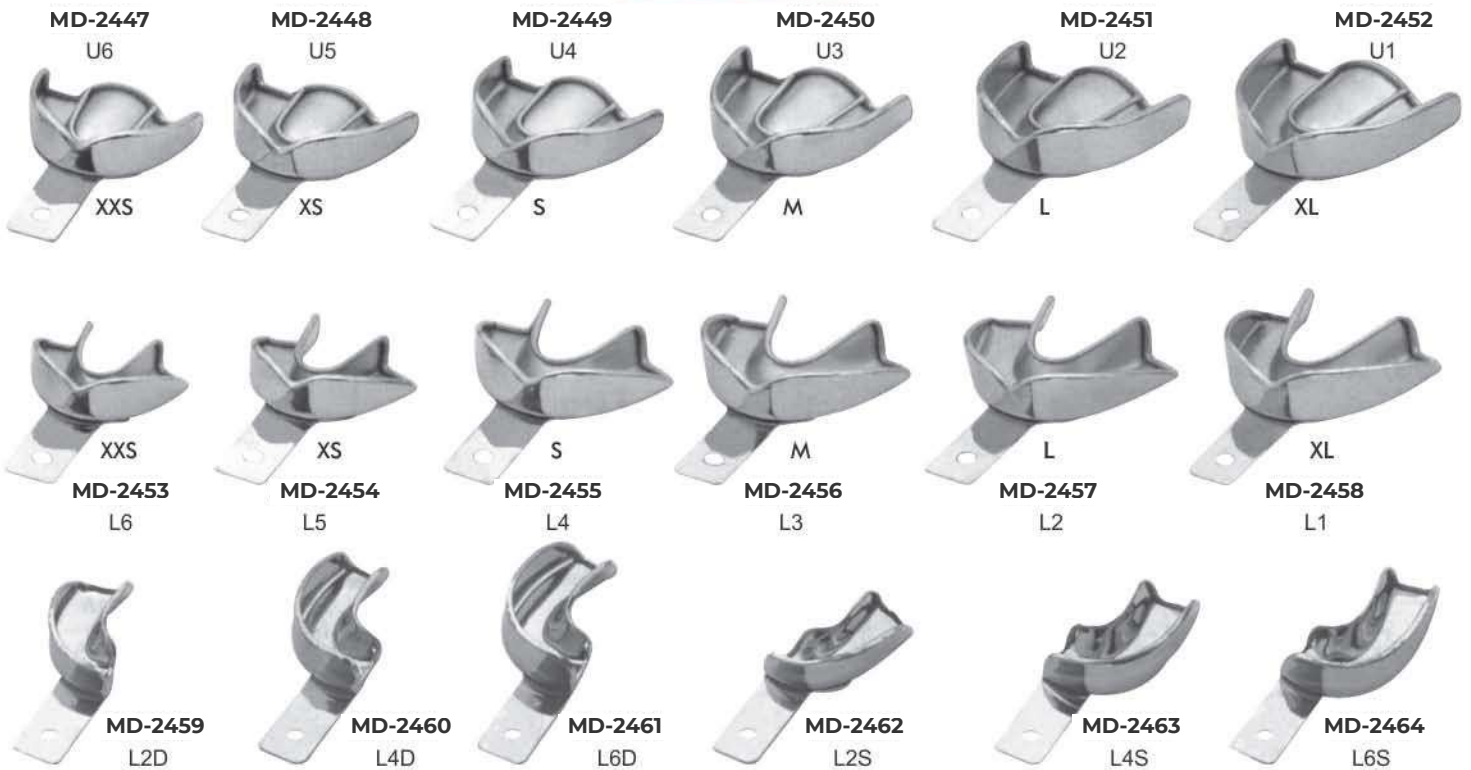





Scalers Tray
MD-2500 200 x 100 mm



Scalers Trays
MD-2501 205 x 115 x 17 mm
MD-2502 205 x 152 x 17 mm
MD-2503 290 x 115 x 17 mm

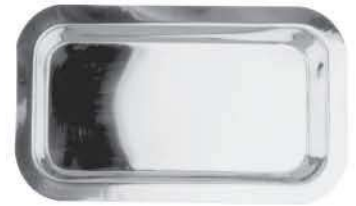

Instruments Trays
MD-2504 200 x 110 x 30 mm
MD-2505 215 x 115 x 35 mm
MD-2506 220 x 130 x 30 mm
MD-2507 230 x 125 x 35 mm
MD-2508 245 x 140 x 40 mm
MD-2509 285 x 160 x 45 mm
MD-2510 315 x 175 x 50 mm
MD-2511 330 x 185 x 50 mm



Instruments Trays
MD-2512 150 x 100 x 50 mm
MD-2513 200 x 100 x 50 mm
MD-2514 220 x 120 x 50 mm
MD-2515 240 x 140 x 50 mm
MD-2516 200 x 150 x 50 mm
MD-2517 250 x 200 x 50 mm
MD-2518 300 x 250 x 50 mm
MD-2519 300 x 200 x 50 mm
MD-2520 350 x 250 x 50 mm
MD-2521 400 x 300 x 50 mm
MD-2522 450 x 300 x 50 mm
MD-2523 450 x 350 x 50 mm



Instruments Trays With Lid
MD-2524 150 x 100 x 50 mm
MD-2525 200 x 100 x 50 mm
MD-2526 220 x 120 x 50 mm
MD-2527 240 x 140 x 50 mm
MD-2528 200 x 150 x 50 mm
MD-2529 250 x 200 x 50 mm
MD-2530 300 x 250 x 50 mm
MD-2531 300 x 200 x 50 mm
MD-2532 350 x 250 x 50 mm
MD-2533 400 x 300 x 50 mm
MD-2534 450 x 300 x 50 mm
MD-2535 450 x 350 x 50 mm



Mayo Tray Perforated
MD-2536 150 x 100 x 25 mm
MD-2537 200 x 100 x 25 mm
MD-2538 220 x 120 x 25 mm
MD-2539 240 x 140 x 25 mm
MD-2540 200 x 150 x 25 mm
MD-2541 250 x 200 x 25 mm
MD-2542 300 x 250 x 25 mm
MD-2543 300 x 200 x 25 mm
MD-2544 350 x 250 x 25 mm
MD-2545 400 x 300 x 25 mm
MD-2546 450 x 300 x 25 mm
MD-2547 450 x 350 x 25 mm



Scaler Tray
MD-2548 200 x 115 mm
MD-2549 205 x 150 mm
MD-2550 290 x 150 mm
MD-2551 300 x 200 mm



Instruments Tray Perforated
MD-2552 150 x 100 x 50 mm
MD-2553 200 x 100 x 50 mm
MD-2554 220 x 120 x 50 mm
MD-2555 240 x 140 x 50 mm
MD-2556 200 x 150 x 50 mm
MD-2557 250 x 200 x 50 mm
MD-2558 300 x 250 x 50 mm
MD-2559 300 x 200 x 50 mm
MD-2560 350 x 250 x 50 mm
MD-2561 400 x 300 x 50 mm
MD-2562 450 x 300 x 50 mm
MD-2563 450 x 350 x 50 mm

Sterilizing boxes & instruments Trays



Instruments Box with Hooks

MD-2564	170 x 70 x 30 mm
MD-2565	180 x 80 x 40 mm
MD-2566	200 x 100 x 40 mm
MD-2567	200 x 100 x 50 mm
MD-2568	220 x 120 x 50 mm
MD-2569	250 x 150 x 50 mm
MD-2570	250 x 200 x 50 mm
MD-2571	300 x 150 x 60 mm
MD-2572	300 x 200 x 50 mm
MD-2573	350 x 250 x 50 mm
MD-2574	400 x 200 x 100 mm
MD-2575	450 x 250 x 50 mm



Instruments Box

MD-2576	170 x 70 x 30 mm
MD-2577	180 x 80 x 40 mm
MD-2578	200 x 100 x 40 mm
MD-2579	200 x 100 x 50 mm
MD-2580	220 x 120 x 50 mm
MD-2581	250 x 150 x 50 mm
MD-2582	250 x 200 x 50 mm
MD-2583	300 x 150 x 60 mm
MD-2584	300 x 200 x 50 mm
MD-2585	350 x 250 x 50 mm
MD-2586	400 x 200 x 100 mm
MD-2587	450 x 250 x 50 mm



Instruments Box Perforated

MD-2588	170 x 70 x 30 mm
MD-2589	180 x 80 x 40 mm
MD-2590	200 x 100 x 40 mm
MD-2591	200 x 100 x 50 mm
MD-2592	220 x 120 x 50 mm
MD-2593	250 x 150 x 50 mm
MD-2594	250 x 200 x 50 mm
MD-2595	300 x 150 x 60 mm
MD-2596	300 x 200 x 50 mm
MD-2597	350 x 250 x 50 mm
MD-2598	400 x 200 x 100 mm
MD-2599	450 x 250 x 50 mm



Gloves Box
DE-2600 300 x 150 mm



Catheters Tray with lid

MD-2601	200 x 60 x 40 mm
MD-2602	200 x 90 x 40 mm
MD-2603	320 x 95 x 50 mm
MD-2604	328 x 90 x 50 mm
MD-2605	365 x 90 x 50 mm
MD-2606	440 x 115 x 50 mm



Box With Filter

MD-2607	100 x 50 mm
MD-2608	250 x 150 mm
MD-2609	150 x 65 mm
MD-2610	200 x 100 mm
MD-2611	300 x 200 mm



Instruments Trays With Cover

MD-2612	210 x 110 x 50 mm
MD-2613	240 x 160 x 50 mm
MD-2614	300 x 180 x 50 mm
MD-2615	360 x 210 x 50 mm
MD-2616	400 x 230 x 55 mm

Instruments Trays Without Cover

MD-2617	210 x 110 x 50 mm
MD-2618	240 x 160 x 50 mm
MD-2619	300 x 180 x 50 mm
MD-2620	360 x 210 x 50 mm
MD-2621	400 x 230 x 55 mm



Instruments Box with lid

MD-2622	170 x 70 x 30 mm
MD-2623	180 x 80 x 40 mm
MD-2624	200 x 100 x 40 mm
MD-2625	200 x 100 x 50 mm
MD-2626	220 x 120 x 50 mm
MD-2627	250 x 150 x 50 mm
MD-2628	250 x 200 x 50 mm
MD-2629	300 x 150 x 60 mm
MD-2630	300 x 200 x 50 mm
MD-2631	350 x 250 x 50 mm
MD-2632	400 x 200 x 100 mm
MD-2633	450 x 250 x 50 mm



Kidney Tray
 MD-2634 160 mm
 MD-2635 200 mm
 MD-2636 250 mm
 MD-2637 280 mm
 MD-2638 300 mm



Kidney Tray Shallow
 MD-2639 170 mm
 MD-2640 220 mm
 MD-2641 240 mm



Kidney Tray With Cover
 MD-2642 160 mm
 MD-2643 200 mm
 MD-2644 250 mm
 MD-2645 280 mm
 MD-2646 300 mm



Kidney Tray
 MD-2647 160 mm
 MD-2648 200 mm
 MD-2649 250 mm
 MD-2650 280 mm
 MD-2651 300 mm



Forceps Jars
 MD-2652 30 x 90 mm
 MD-2653 50 x 100 mm
 MD-2654 50 x 130 mm
 MD-2655 50 x 175 mm
 MD-2656 75 x 100 mm
 MD-2657 75 x 130 mm
 MD-2658 75 x 175 mm
 MD-2659 100 x 175 mm
 MD-2660 100 x 200 mm



Methot Jar Without Lid
 DE-2661



Dressing Jar / Cotton Container
 MD-2662 80 x 80 mm
 MD-2663 100 x 60 mm
 MD-2664 100 x 80 mm
 MD-2665 100 x 100 mm
 MD-2666 120 x 80 mm
 MD-2667 120 x 100 mm
 MD-2668 150 x 100 mm
 MD-2669 150 x 150 mm
 MD-2670 180 x 150 mm
 MD-2671 180 x 180 mm
 MD-2672 200 x 200 mm
 MD-2673 240 x 240 mm



Sputum Cup
 MD-2674



Dressing Jar With Lid & Knob
 MD-2675 80 x 80 mm
 MD-2676 90 x 90 mm
 MD-2677 100 x 100 mm
 MD-2678 120 x 120 mm
 MD-2679 100 x 130 mm
 MD-2680 150 x 150 mm
 MD-2681 125 x 170 mm



Round Bowls
 MD-2682 80 x 35 mm
 MD-2683 125 x 60 mm



Spirit Lamp
MD-2684



Spirit Lamp
MD-2685



Spirit Lamp
MD-2686



Cotton Holding Jar
MD-2687



Cotton Holder
MD-2688



Cotton Holder
MD-2689



Cotton Wool Dispenser Acc.
to Methot
MD-2690



Needle Sterilization Tub
MD-2691



Round Endodontic Boxes
complete with lid
MD-2692 Ø mm. 94 - h. mm. 70



Endodontic Box
MD-2693

HOLLOWWARE INSTRUMENTS



DE-2694
100 x 180 x 11mm
Mini size



MD-2695
100 x 180 x 11mm
Mini size



MD-2696
100 x 180 x 11mm
Mini size



MD-2697
100 x 180 x 11mm
Mini size



MD-2698
100 x 180 x 11mm
Mini size



Lid
Coperchio
MD-2699
103 x 182 x 10mm
Mini size



MD-2700
Silver



MD-2701 Blue
MD-2702 Red



MD-2703 Blue
MD-2704 Red



MD-2705
Silver



MD-2706
Green



MD-2708
Blue



MD-2707
Golden



MD-2709
Red



MD-2710
Silver



MD-2711
Midi
125 x 105 x 54mm



MD-2712
Maxi
204 x 105 x 54mm

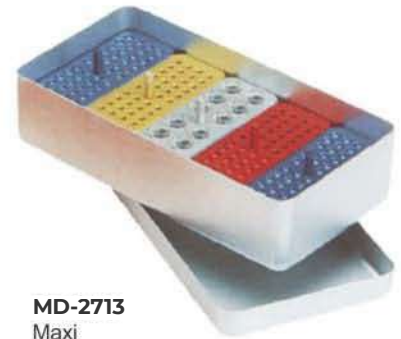

MD-2713
Maxi
204 x 105 x 54mm



Round Sterilizer Drum

MD-2714	mm. Ø 80 x 80 H
MD-2715	mm. Ø 125 x 80 H
MD-2716	mm. Ø 125 x 100 H
MD-2717	mm. Ø 125 x 125 H
MD-2718	mm. Ø 150 x 80 H
MD-2719	mm. Ø 150 x 100 H
MD-2720	mm. Ø 150 x 130 H
MD-2721	mm. Ø 150 x 150 H
MD-2722	mm. Ø 150 x 190 H
MD-2723	mm. Ø 190 x 125 H
MD-2724	mm. Ø 190 x 145 H
MD-2725	mm. Ø 190 x 165 H
MD-2726	mm. Ø 190 x 190 H
MD-2727	mm. Ø 190 x 240 H
MD-2728	mm. Ø 190 x 290 H
MD-2729	mm. Ø 240 x 120 H
MD-2730	mm. Ø 240 x 145 H
MD-2731	mm. Ø 240 x 165 H
MD-2732	mm. Ø 240 x 190 H
MD-2733	mm. Ø 240 x 240 H
MD-2734	mm. Ø 240 x 290 H
MD-2735	mm. Ø 240 x 340 H
MD-2736	mm. Ø 240 x 390 H
MD-2737	mm. Ø 290 x 145 H
MD-2738	mm. Ø 290 x 165 H
MD-2739	mm. Ø 290 x 190 H
MD-2740	mm. Ø 290 x 240 H
MD-2741	mm. Ø 290 x 290 H
MD-2742	mm. Ø 290 x 340 H
MD-2743	mm. Ø 290 x 390 H
MD-2744	mm. Ø 340 x 145 H
MD-2745	mm. Ø 340 x 165 H
MD-2746	mm. Ø 340 x 190 H
MD-2747	mm. Ø 340 x 240 H
MD-2748	mm. Ø 340 x 290 H
MD-2749	mm. Ø 340 x 340 H
MD-2750	mm. Ø 340 x 390 H
MD-2751	mm. Ø 390 x 140 H
MD-2752	mm. Ø 390 x 165 H
MD-2753	mm. Ø 390 x 190 H
MD-2754	mm. Ø 390 x 240 H
MD-2755	mm. Ø 390 x 290 H
MD-2756	mm. Ø 390 x 340 H
MD-2757	mm. Ø 390 x 390 H
MD-2758	mm. Ø 390 x 490 H



Round Sterilizer Drums "Filter"

MD-2759	mm. Ø 80 x 80 H
MD-2760	mm. Ø 125 x 80 H
MD-2761	mm. Ø 125 x 100 H
MD-2762	mm. Ø 125 x 125 H
MD-2763	mm. Ø 150 x 100 H
MD-2764	mm. Ø 150 x 130 H
MD-2765	mm. Ø 150 x 150 H
MD-2766	mm. Ø 150 x 190 H
MD-2767	mm. Ø 190 x 145 H
MD-2768	mm. Ø 190 x 165 H
MD-2769	mm. Ø 190 x 190 H
MD-2770	mm. Ø 190 x 240 H
MD-2771	mm. Ø 240 x 145 H
MD-2772	mm. Ø 240 x 165 H
MD-2773	mm. Ø 240 x 190 H
MD-2774	mm. Ø 240 x 240 H
MD-2775	mm. Ø 240 x 290 H
MD-2776	mm. Ø 240 x 340 H
MD-2777	mm. Ø 240 x 390 H
MD-2778	mm. Ø 290 x 145 H
MD-2779	mm. Ø 290 x 165 H
MD-2780	mm. Ø 290 x 190 H
MD-2781	mm. Ø 290 x 240 H
MD-2782	mm. Ø 290 x 290 H
MD-2783	mm. Ø 290 x 340 H
MD-2784	mm. Ø 290 x 390 H
MD-2785	mm. Ø 340 x 145 H
MD-2786	mm. Ø 340 x 165 H
MD-2787	mm. Ø 340 x 190 H
MD-2788	mm. Ø 340 x 240 H
MD-2789	mm. Ø 340 x 290 H
MD-2790	mm. Ø 390 x 140 H
MD-2791	mm. Ø 390 x 165 H
MD-2792	mm. Ø 390 x 190 H
MD-2793	mm. Ø 390 x 240 H
MD-2794	mm. Ø 390 x 290 H
MD-2795	mm. Ø 390 x 340 H
MD-2796	mm. Ø 390 x 490 H



Round Bowls With Cover

MD-2797	Ø 40 mm ml.30
MD-2798	Ø 60 mm ml.50
MD-2799	Ø 80 mm ml.150
MD-2800	Ø 100 mm ml.250
MD-2801	Ø 120 mm ml.450
MD-2802	Ø 150 mm ml.750
MD-2803	Ø 180 mm ml.1500
MD-2804	Ø 200 mm ml.2100
MD-2805	Ø 250 mm ml.3500

Round Bowls With Out Cover

MD-2806	Ø 40 mm ml.30
MD-2807	Ø 60 mm ml.50
MD-2808	Ø 80 mm ml.150
MD-2809	Ø 100 mm ml.250
MD-2810	Ø 120 mm ml.450
MD-2811	Ø 150 mm ml.750
MD-2812	Ø 180 mm ml.1500
MD-2813	Ø 200 mm ml.2100
MD-2814	Ø 250 mm ml.3500

INSTRUMENTS MANAGEMENT SYSTEM

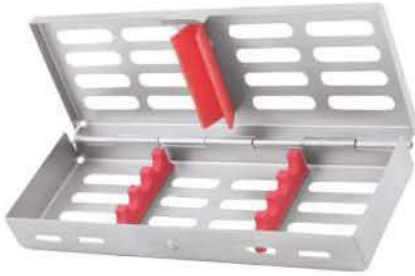

Cassette For 4 Instruments
MD-2815



Cassette For 5 Instruments
MD-2816



Cassette For 6 Instruments
MD-2817



Cassette For 7 Instruments
MD-2818



Cassette For 10 Instruments
MD-2819



Cassette For 20 Instruments
MD-2820



Cassette For Extraction Forceps
MD-2821



Cassette For Root Elevator
MD-2822



MD-2823
Cassette Tray
15 Pcs



MD-2824
Cassette Tray
15 Pcs

STERILIZING MESH TRAY

Different sizes & dimensions are available at buyer's demand



MESH TRAYS
MD-2825
Different sizes & dimensions are available at buyer's demand



MESH TRAYS
MD-2826
05 Pcs



MESH TRAYS
MD-2827
07 Pcs



MESH TRAYS
DE-2828
10 Pcs



MESH TRAYS
MD-2829
20 Pcs



MD-2830
Mesh Cassettes
5 Pieces, 7 Pieces, 10 Pieces,
15 Pieces & 20 Pieces



MESH TRAY
MD-2831 240x130x50mm
MD-2832 240x130x60mm
MD-2833 240x250x50mm
MD-2834 240x250x60mm
MD-2835 480x250x50mm
MD-2836 480x250x60mm
MD-2837 480x250x70mm



MESH TRAY
MD-2838 240x250x 50mm
MD-2839 240x250x 60mm
MD-2840 240x250x 70mm
MD-2841 480x250x 50mm
MD-2842 480x250x 60mm
MD-2843 480x250x 70mm
MD-2844 480x250x100mm



MESH TRAY
MD-2845 240x250x50mm
MD-2846 240x250x60mm
MD-2847 240x250x70mm
MD-2848 280x250x50mm
MD-2849 280x250x60mm



MESH TRAY
MD-2850 280x250x 70mm
MD-2851 280x250x100mm
MD-2852 280x250x 50mm
MD-2853 280x280x 60mm
MD-2854 280x280x 70mm
MD-2855 300x280x 60mm



MD-2856
18×7×3.5cm
5 Instruments Cassette
Detachable Lids
+
5 Instruments Cassette Hinged
Lids with button Lock



MD-2857
29×18.5×3.5cm
20 Instruments Cassette Hinged
Lids with surgical kit fitting,
button lock



Instruments Cassette
MD-2858 5 Pieces Cassette
MD-2859 7 Pieces Cassette
MD-2860 10 Pieces Cassette



MD-2861
18×11×3.5cm
Extra large cassette for 6
Instruments, with compartment
for small parts hinged lids



MD-2862
29×18.5×3.5cm
20 Instruments Cassette
Detachable Lids
+
20 Instruments Cassette Hinged
Lids with button Lock



MD-2863
10×13×2.2cm
10 Instruments Cassette Hinged
Lids, Click Lock Available in 2
designs



MD-2864
29×18.5×3.5cm
20 Instruments Cassette Detachable
Lids with elevator fitting
+
20 Instruments Cassette Hinged
Lids with elevator fitting , button lock

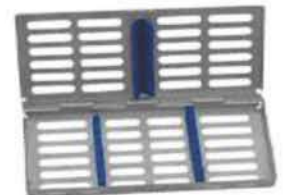

MD-2865
18×9×2.2cm
7 Instruments Cassette Hinged
Lids, Click Lock, Available in 2
designs



MD-2866
21×14×3.5cm
15 Instruments cassette,
Detachable lids, button lock



MD-2867
21×14×3.5cm
15 Instruments cassette,
detachable lids, button
lock, with fitting of micro
surgery kit



MD-2868
21×14×4.5cm
8 pcs luxator/elevator
cassette, Detach0
ablelids, button lock



MD-2869
15×9×5cm
Box for dental implant tools and
surgical kits, Capacity:8
tools, 18 tools, 24 Tools, 58 Tools
+ removable compartment



Instruments Tray Perforated
DE-2870 288 x 187 x 40 mm



Instruments Tray Perforated Base
MD-2871 288 x 187 x 40 mm



Instruments Tray Solid Base
MD-2872 288 x 187 x 40 mm



MD-2873 Implant Basic Starter Kit 11 instruments with case



MD-2874 Crown Bridge Set Instruments with Case



MD-2875 Bone Curettes Spoon Style set of 4 with Metal Case



MD-2876 Peritome Set of 2 with Blue Nitrate Tips and Metal Case



MD-2877 Root Fragment Removal elevators, Set of 4 with Metal Case



MD-2878 Peritome Set of 3 Gold Handles Serrated Blades with Metal Case

DESCRIPTION	PAGE#
A	
A COSMETIC CONTOURING IMPLANTOLOGY	148
AB1 BOGHOSIAN IMPLANTOLOGY	147
AB2 BOGHOSIAN IMPLANTOLOGY	147
ABDU-RASS EXPLORERS	54
ACUTE IMPLANTOLOGY	161
ADAMS PLIER	133
ADAMS PLIER ROUND BOX	133
ADAMS PLIERS FOR HOOKS AND BENDING	138
ADAMS, SMALL WIRE BENDING AND LOOP FORMING PLIERS	132
ADERER CLAMP THREE JAW WIRE BENDING PLIER	138
ADERER FACEBOW LOOP FORMING PLIERS	134
ADERER LARGE WIRE BENDING AND LOOP FORMING PLIERS	133
ADERER PLIER	134
ADHESIVE REMOVING PLIERS	36,141
ADSON 7X7 CURVED TISSUE FORCEPS	169
ADSON BROWN TWEEZERS	53
ADSON CARBIDE TIPPED TISSUE FORCEPS	169
ADSON NEEDLE HOLDERS	107
ADSON-TC TWEEZERS	53
ADULT PALATAL DENTAL PHOTOGRAPHIC MIRRORS	98
ALLIS HAEMOSTATIC FORCEPS	110
ALLIS-BABY HAEMOSTATIC FORCEPS	110
ALL-PURPOSE PLIERS	109
ALUMINIUM CALIPER	127
ALM RETRACTOR	102
AMALGAM CARRIERS	117
AMALGAM INSTRUMENTS	116,117
AMALGAM WELL	115,117
ANATOMIC HANDLE EXPLORERS	54
ANDREWS FILLING INSTRUMENTS	87
ANGLE HOW PLIER	139
ANGLED DIRECT BOND BRACKET REMOVER TC	139
ANGLED EXTRACTING FORCEPS FOR UPPER ROOTS	03
ANGLED UTILITY PLIERS	136
ANISWORTH RUBBER DAM CLAMPS FORCEPS	111
ANTERIOR	58
APEX FORCEPS LOWER ROOT DEEP ROOT PICK	06
APEX FORCEPS LOWER UNIVERSAL DEEP ROOT PICK	05
APEXO ROOT ELEVATORS	29
APICAL RETENTION FORCEPS	23
APICAL ROOT ELEVATORS	31,33
ARCH BENDING PLIERS	38,143
ARROW CLASP FORMING PLIERS	139
ARTICULATORS	97
ASPIRATING SYRING	27
ATRAUMATIC TWEEZERS	52
ATRAUMATIC WITH LOCK TWEEZERS	52
B	
BABY TOOTH EXTRACTION FORCEPS SET OF 7 PIECES	08
BACK ACTION FILLING INSTRUMENTS	88
BACKHAUS HAEMOSTATIC FORCEPS	110
BACKHAUS TOWEL CLAMPS	110
BACOLITE HANDLE WAX KNIVES	96
BALL BURNISHERS	71
BALL FILLING INSTRUMENTS	93
BALL SOCKET NOT-PERFORATING AND NOT-DAMAGING	110
BALLACORN FILLING INSTRUMENTS	88
BAND REMOVING PLIERS	32,136
BAND SEATER AUTO CLEAVABLE	129
BAND SEATER AUTO CLEAVABLE ROUND SHAPE	129
BAND SEATER AUTO CLEAVABLE SQUARE SHAPE	129
BAND SEATER AUTO CLEAVABLE TRIANGLE SHAPE	129
BAND SEATING & REMOVING INSTRUMENTS	129
BAND SEATING & REMOVING SILICON GRIP	129
BAND SEATING PLIERS	141
BANDS & CROWNS PLIER	134
BARRAQUER T.C NEEDLE HOLDERS	109
BASINS FOR BONE	174
BAUMGARTNER NEEDLE HOLDERS	06,107
BAYONET ROOTS ELEVATOR SET	36
BEAVERTAIL FILLING INSTRUMENTS	88
BEEBEE GUM SCISSORS	106
BEERENDONK CALIPER	127
BEIN ROOT ELEVATORS	29,40
BENDING PLIER	138
BESEK COMPOSITE INSTRUMENTS	72
BESEK COMPOSITE MODELLING INSTRUMENTS	85
BESEK COMPOSITE PLUGGERS INSTRUMENTS	82
BESEK PLUGGERS	76
BEYER BONE ROUNDER	25
BINANGLE SCALER	67
BIRD BEAK PLIER	38,141
BIRD BEAK PLIER FOR BENDING	138
BIRD BEAK PLIER STANDARD	133
BIRD BEAK WIRE BENDING & CUTTING PLIERS	134
BIRD BEAK WIRE BENDING PLIER	133
BISHOP RETRACTORS	101
BLACK FILLING INSTRUMENTS	80,87
BLACK SCALER	66
BLACK TITANIUM COLOUR COATED INSTRUMENTS	147,148,149
BLADE AND PUSHER	166
BLUE TITANIUM COATED BONE GRAFTING INSTRUMENTS	59,187
SET OF 7 PCS WITH CASSETTE	159
BLUMENTHAL BONE ROUNDER	25
BOLEY GAUGE	127
BONE BRACKET GAUGE	125
BONE CARRIER TITANIUM	165
BONE CRUSHER	174
BONE CRUSHER TITANIUM METAL CUTTER	174
BONE EXPANDER KIT	176
BONE EXPANDER SCREW & SURGICAL KITS	176
BONE FILES	119
BONE GRAFT	159
BONE GRAFT IMPLANTOLOGY	164
BONE GRAFT PACKER	164
BONE GRAFT/CARRIER TITANIUM	167
BONE GRAFTING INSTRUMENTS COMPACTOR /TAMPERS	166
BONE INJECTORS, COLLECTORS & SUCTION TUBE	175
BONE MILL	174
BONE ROUNDER	25
BONE SCRAPER	173
BONE SCRAPER STRAIGHT & CURVED	173
BONE SPOON/PACKER	166

DESCRIPTION	PAGE#
BONE THICKNESS GAUGE	146
BONE UNIVERSAL KIT	176
BONE WELL	174
BOX FOR DENTAL IMPLANT TOOLS AND SURGICAL KITS	191
BOX JOINT PLIERS	132,133,134
BRACKET HOLDER TWEEZERS	128
BRACKET PLACER TWEEZERS	128
BRACKET PLACING TWEEZES	132
BRACKET REMOVING PLIER CURVED	132
BRACKET REMOVING PLIER ROUND BOX	132
BRACKET REMOVING PLIERS ANGLED	136
BRACKET REMOVING PLIERS STRAIGHT	136
BRACKET REMOVING PLIERS WITH PLASTIC TIP	136
BRACKET TWEEZERS SLOT ALIGNER	128
BREWER RUBBER DAM CLAMPS FORCEPS	111
BRUENINGS RETRACTORS	101
BUCCAL AND LINGUAL/PALATAL SCALER	61
BUCCAL DENTAL PHOTOGRAPHIC MIRRORS	98
BUCCAL SURFACES SCALER	61
BUCCAL SMALL DENTAL PHOTOGRAPHIC MIRRORS	98
BURNISHER FILLING INSTRUMENTS	78,88
BURNISHERS	149
BURNISHERS CONSERVATIVE TREATMENT	68,71
BUSER PERIODONTAL INSTRUMENTS	121
C	
COSMETIC CONTOURING IMPLANTOLOGY	148
CARBIDE DIAMOND COATED POINT	24
CARRY FORCEPS	170
CARVER COMPOSITE MODELLING INSTRUMENTS	85
CARVERS INSTRUMENTS	89,90
CARVERS INSTRUMENTS CASSETTE FOR 5 INSTRUMENTS	90
CASSETTE FOR INSTRUMENTS	162
CASTROVIEJO CALIPERS	126
CASTROVIEJO GUM SCISSORS	105
CASTROVIEJO MICRO SCISSORS	108
CASTROVIEJO NEEDLE HOLDERS	107,109
CATHETERS TRAY WITH LID BOX WITH FILTER	184
CATRIDGE SYRING	27
CEMENT SPATULAS	95
CERI SAW	124
CHEEK RETAINER	101
CHILD PALATAL DENTAL PHOTOGRAPHIC MIRRORS	98
CHIP BLOWER	116
CHISELS, BONE FILES & SPOONE CURETTE	118
CHISELS SCALER	65,67
CHOMPRET ROOT ELEVATOR	42
CINCH BACK / TIE BACK DISTAL END BENDING PLIERS	137
CLAW-LIFT ROOTS ELEVATOR	37
COARSE SUCTION TUBES	178
COBRA IMPLANTOLOGY	156
COHEN UNIVERSAL EXTRACTING FORCEPS (AMERICAN PATTERN)	17
COLLEGE FORCEPS	51
COLLEGE TWEezer	53
COLLEGE WITH LOCK TWEEZERS	52
COLLINS TONGUE FORCEPS	110
COLUMBIA RETRACTOR	99
COMBINATION RETRACTORS	101
COMELLAS FORCEPS ANATOMICAL HANDLE	26
COMPASSO DE WILLIS	127
COMPOSITE BALL PLUGGERS	76
COMPOSITE FILLING INSTRUMENTS	92,93
COMPOSITE FILLING INSTRUMENTS SET OF 6 PCS	93
COMPOSITE GOLD TIP INSTRUMENTS	93
COMPOSITE INSTRUMENTS	72,73
COMPOSITE INSTRUMENTS BLUE TITANIUM WITH CASSETTES	89
COMPOSITE INSTRUMENTS TITANIUM BLUE ENDODONTIC	89
COMPOSITE MODELLING INSTRUMENTS	85
COMPOSITE PLUGGERS INSTRUMENTS	82,83
COMPOSITE/PLASTIC FILLING INSTRUMENTS	87
CONDENSER IMPLANTOLOGY	150,161
CONE-SOCKET MOUTH MIRRORS	49
CONE-SOCKET FRONT SURFACE MOUTH MIRRORS	49
CONE-SOCKET MIRROR HANDLES FOR MOUTH MIRRORS	50
CONE-SOCKET PLAIN MOUTH MIRRORS	49
CONE-SOCKET RHODIUM MOUTH MIRRORS	49
CONE-SOCKET SOLID HANDLES FOR MOUTH MIRRORS	50
CONE-SOCKET SOLID OCTAGONAL HANDLES FOR MOUTH MIRRORS	50
CONTOURING PLIER	134,138
COPERCHIO HOLLOWARE INSTRUMENTS	167
CORROSION RESISTANT	145
COTTON HOLDER	186
COTTON HOLDING JAR	186
COTTON WOOL DISPENSER ACC. TO METHOT	186
COUPLAND ROOT ELEVATORS	34
CRANE KAPLAN TWEEZERS	53
CRILE-WOOD NEEDLE HOLDERS	106,107
CROWN REMOVER	114
CROWN SPREADERS	114
CRUCIBLE TONGS	124
CRUYER EXTRACTING FORCEPS (AMERICAN PATTERN)	12,13,19,20
CRUYER ROOT ELEVATORS	32
CUTTER	139,142
CUTTER, UTILITY PLIERS & WIRE FORMING PLIERS	141
D	
DEAN GUM SCISSORS	105
DEBAKEY ATRAUMATIC TISSUE FORCEPS	169
DELUX BOLEY GAUGE	127
DELUXE BRACKET HOLDER	128
DELUXE BRACKET HOLDER TWEEZERS	128
DENHARD RETRACTORS - MOUTH GAGS	100
DENTAL PHOTOGRAPHIC MIRRORS	98
DENTAL SYRINGES	27
DENTAURUM CALIPER	127
DERF NEEDLE HOLDERS	106,107
DETAILING STEP PLIER	139
DETAILING STEP PLIERS / BAYONET BENDING PLIERS	137
DIAMOND COATED MARGIN TRIMMERS	65
DIRECT BOND BRACKET HOLDER TWEEZERS	128
DIRECT BOND BRACKET HOLDER TWEEZERS, SMALL TIP	128
DIRECT BONDING BRACKET HOLDERS	128
DIRECT BRACKET REMOVER TC	140
DISC SYSTEM DENTAL SYRINGES	27
DISSECTING SET SET OF 11 PCS	94
DISSECTING SET SET OF 9 PCS	94

DESCRIPTION PAGE#

DISTAL AMALGAM CARRIERS	117
DISTAL BENDER SILICON GRIP	129
DISTAL CUTTER	139
DISTAL END CUTTER	135
DISTAL END CUTTER FLUSH CUT	142
DISTAL END CUTTER, SAFETY HOLD PLIER (IDEAL FOR CUTTING WIRE) TC	140
DISTAL END WIRE CUTTERS & BRACKET REMOVER PLIERS	140
DISTAL SCALER	81,83
DOUBLE ENDED CEMENT SPATULA	131
DOUBLE ROUNDED JAW BENDING PLIERS	138
DOUBLE ENDED EXPLORERS	54
DRESSING TWEEZERS	52,53
DYNAMOMETER	148

E	
EASY ACCESS TWEEZERS	128
EBNETER SCALER	64
ELASTIC INSTRUMENT SILICON GRIP	129
ELASTIC SEPARATING PLIER	140
ELASTIC SEPARATING PLIER ROUND HANDLE	140
ELASTOMERIC LIGATURE PLACING FORCEPS WITH GROOVE FALCON	140
ELEVATORS SET OF 8 PCS	46
ELEVATORS SET OF 8 PCS	46
ELLIOT SIQVELAND RETAINERS	115
ENDO FINGER RULER SPAN MEASURE SCALE	125
ENDODONTIC BOX	186
ENDODONTIC EXPLORER	154
ENDODONTICS INSTRUMENTS	58
ERGO GRIP RETRACTOR	101
EURO BREECH LOADING/DENTAL SYRINGES	27
EXAVATORS EXPLORERS	51
EXCAVATOR INSTRUMENTS	74
EXCAVATORS	86
EXECT BRACKET HOLDER TWEEZERS	128
EXPLORERS	51,54,55,58
EXTRACTING FORCEPS (AMERICAN PATTERN)	126to24
EXTRACTING FORCEPS (ENGLISH PATTERN)	01to07,26

EXTRACTING FORCEPS (ENGLISH PATTERN) SET OF 10 PIECES	07
EXTRACTING FORCEPS	08
EXTRACTING FORCEPS AMERICAN ADULT SET OF 10 PCS	28
EXTRACTING FORCEPS AMERICAN ADULT SET OF 8 PCS	28
EXTRACTING FORCEPS CHILDREN PATTERN SET OF 10 PCS	28
EXTRACTING FORCEPS ENGLISH ADULT SET OF 10 PCS	28
EXTRACTING FORCEPS PEDO SET OF 7 PCS	28
EXTRACTING FORCEPS SET	28
EXTRACTING FORCEPS SET OF 10 PIECES	28
EXTRACTING FORCEPS SET OF 10 PIECES	28
EXTRACTING FORCEPS SET OF 13 PIECES	28
EXTRA-FLEX IMPLANTOLOGY	147

F	
FALCON BEAK CONTOURING PLIERS	133,138
FARABEUF RETRACTORS SET OF 2 PICES)	103
FELDMAN RETRACTOR	103
FILLING INSTRUMENTS (GOLD POINTED)	91
FILLING INSTRUMENTS	87,88,91,93
FILLING INSTRUMENTS CONSERVATIVE TREATMENT	69,70,75,78,79,81,84
FIRST AID EXAMINATION SET OF 3 PICES	51
FLEXIBLE PERITOME	163
FLEXI-THIN IMPLANTOLOGY	147
FLOHR ROOT ELEVATORS	79,133
FLUSH-CUT DISTAL AND CUTTING PLIERS	133
FLUSH-CUT DISTAL END CUTTER	135
FOERSTER DRESSING FORCEPS	110
FRAZIER SUCTION TUBES WITH FILTER	178
FREEDMAN "DUCKHEAD"	149
FREEDMAN BURNISHERS	149
FREEDMAN LARGE CONTACT FORMING	149
FREEDMAN SMALL CONTACT FORMING	149
FREER PERIODONTAL INSTRUMENTS	121
FREER PERIOSTEEL ELEVATORS	120
FRET SAW	124
FRIEDMAN BONE ROUNDER	25
FRIEDMANN ROOT ELEVATOR	36
FRIEDMANNRICHARD PERIODONTAL INSTRUMENTS	122
FUZZI COMPOSITE MODELLING INSTRUMENTS	85

G	
GERALD TWEEZERS	52
GILLIES TWEEZERS	52
GILLIES NEEDLE HOLDER WITH SCISSORS	107
GLOVES BOX	184
GOLD COLOR SET DENTAL ORAL IMPLANTOLOGY SINUS SET OF 10 PCS WITH CASSETTE	156
GOLD MILL (LARGE)	174
GOLD MILL (SMALL)	174
GOLDMAN FOX SUPER CUT SCISSORS	108
GOLDMAN FOX EXPLORERS	55
GOLDMAN FOX SCISSORS	108
GOLDMAN-FOX GUM SCISSORS	104,105
GOLDMAN-FOX PERIODONTAL INSTRUMENTS	121
GOLDMANN-FOX SCALER	64
GRACEY AFTER FIVE	80
GRACEY CURETTES SCALER	81
GRACEY CURETTES	59,63
GRACEY MINI FIVE	80
GRACEY SCALER	61
GRAFT MATERIAL SPOON CONCAVE TIP FOR LARGER GRAFTS	185
GRAFT PACKER	166
GRAFT PACKER, CONCAVE	166
GRIPPER CARBIDE TIPPED TISSUE FORCEPS TC	169
GRITMAN CEMENT SPATULAS	95
GROSS MAIER DRESSING FORCEPS	110
GULDENER SCALER	64
GUM SCISSORS	104to108

H	
HAEMOSTATIC FORCEPS & TOWEL CLAMPS	110
HALSEY NEEDLE HOLDERS	106,107
HALSTEAD MOSQUITO HAEMOSTATIC FORCEPS	110
HALSTEAD MOSQUITO NEEDLE HOLDERS	107
HALTEPINZETTE WITH LOCK TWEEZERS	170

DESCRIPTION PAGE#

HAMMER HEAD DISTAL END BENDING PLIERS	137
HAMMER WITH WOODEN HANDLE	124
HANDLE ROUND HANDLES FOR MOUTH MIRRORS	50
HANDLES FOR MOUTH MIRRORS	50
HARD WIRE CUTTER	142
HARD WIRE CUTTER STRAIGHT	142
HARD WIRE CUTTER, 15° ANGLED	135
HARD WIRE CUTTER, 15° ANGLED NON-AUTOCALAVABLE	135
HARD WIRE CUTTER, STRAIGHT	135
HARD WIRE CUTTERS	140
HARRIS EXTRACTING FORCEPS (AMERICAN PATTERN)	13,18
HARTMANN (BABY MOSQUITO) NEEDLE HOLDERS	107
HEAT CARRIERS	57
HEBER BAYONET ROOTS ELEVATOR	40
HEBER ROOTS ELEVATOR	40
HEIDBRINK ROOT APPEX ELEVATOR	44
HEIDBRINK ROOT ELEVATORS	33,43
HEIDBRINK ROOTS ELEVATOR WARWICK-JAMES	44
HEIDEMANN FILLING INSTRUMENTS	93
HEIDEMANN SPATULAS	73
HEIGHT GAUGE 0.18 STAINLESS STEEL	125
HEIGHT GAUGE ALUMINIUM	125
HEMINGWAY TWEEZERS	53
HEX TORQUE WRENCH UNIVERSAL	177
HEXAGONAL HANDLES FOR MOUTH MIRRORS	50
HIRSCHFELD PERIODONTAL INSTRUMENTS	122
HIRT COMPOSITE MODELLING INSTRUMENTS	85
HIRT COMPOSITE PLUGGERS INSTRUMENTS	83
HIRT SCALER	66
HMG HEISTER	99
HOLLENBACK FILLING INSTRUMENTS	80,87
HOLLOW CHOP CONTOURING PLIERS	143
HOLLOW HANDLES FOR MOUTH MIRRORS	50
HOLLOW MIRROR HANDLES FOR MOUTH MIRRORS	50
HOLLOWWARE INSTRUMENTS	183,184,186,187,190,191
HOLZ SCALER	65
HOOK CRIMPING PLIER ANGLED STRAIGHT TC	140
HOOK KNIVES	96
HOPSON FILLING INSTRUMENTS	78
HOW PLIER	132
HOW PLIER CURVED	132
HOW PLIERS OFFSET	141
HOW PLIERS STRAIGHT	141
HOW STRAIGHT UTILITY PLIERS	136
HOWARD PERIOSTEEL ELEVATORS	120
HULL EXTRACTING FORCEPS (AMERICAN PATTERN)	19
HYLIN CEMENT SPATULAS	95
HYLIN ROOTS ELEVATOR	39

I	
IMPLANT GAGES	145
IMPLANT SINUS LIFT INSTRUMENTS	161,162
IMPLANTOLOGY	145to178
IMPLANTOLOGY 9 PCS OF SET	161
IMPLANTOLOGY SET OF 2 COMPOSITE BLUE TIP INSTRUMENTS	154
IMPLANTOLOGY SET OF 3 COMPOSITE BLUE TIP INSTRUMENTS	154
IMPLANTOLOGY SET OF 4 COMPOSITE BLUE TIP INSTRUMENTS	154
IMPLANTOLOGY SET OF 5 COMPOSITE GOLD TIP INSTRUMENTS	154
IMPRESSION TRAYS	179to182
IMPRESSION TRAYS PERFORATED FULL DENTURE SET OF 8 PCS	181
IMPRESSION TRAYS PERFORATED WITHOUT RIM LOCK	182
IMPRESSION TRAYS SOLID FULL DENTURE SET OF 06 PCS	181
IMPRESSION TRAYS SOLID FULL DENTURE SET OF 8 PCS	181
IMPRESSION TRAYS SOLID WITH RIM LOCK	182
IMPRESSION TRAYS SOLID WITH RIM LOCK SET OF 06 PCS	180
IMPRESSION TRAYS SOLID WITH RIM LOCK SET OF 08 PCS	180
IMPRESSION TRAYS SOLID WITH RIM LOCK SET OF 10 PCS	180
INSTRUMENTS BOX	184
INSTRUMENTS BOX PERFORATED	184
INSTRUMENTS BOX WITH HOOKS	184
INSTRUMENTS BOX WITH LID	184
INSTRUMENTS CASSETTE 10 HINGED	191
INSTRUMENTS CASSETTE 10 PIECES CASSETTE	191
INSTRUMENTS CASSETTE 15 SURGERY KIT	191
INSTRUMENTS CASSETTE	191
INSTRUMENTS CASSETTE 20 DETACHABLE	191
INSTRUMENTS CASSETTE 20 DETACHABLE LIDS	191
INSTRUMENTS CASSETTE 20 HINGED	191
INSTRUMENTS CASSETTE 5 DETACHABLE LIDS	191
INSTRUMENTS CASSETTE 5 HINGED LIDS WITH BUTTON LOCK	191
INSTRUMENTS CASSETTE 5 PIECES CASSETTE	191
INSTRUMENTS CASSETTE 7 INHINGED	191
INSTRUMENTS CASSETTE 7 PIECES CASSETTE	191
INSTRUMENTS TRAY PERFORATED	183,191
INSTRUMENTS TRAY PERFORATED BASE	191
INSTRUMENTS TRAY SOLID BASE	191
INSTRUMENTS TRAYS	183
INSTRUMENTS TRAYS WITH COVER	184
INSTRUMENTS TRAYS WITH LID	183
INSTRUMENTS TRAYS WITHOUT COVER	184
INTRALIGAMENTAL ANESTHESIA SYRINGE	27
IRIS GUM SCISSORS	104
IRIS SUPER CUT SCISSORS	108
IRIS GUM SCISSORS	104,105,108
IVORY SIQVELAND RETAINERS	115
IVORY LIGHT WEIGHT RUBBER DAM CLAMPS FORCEPS	111
IVORY MATRIX RETAINERS	115
IVORY RETRACTORS	101
IVORY RUBBER DAM CLAMPS FORCEPS	111
IWANSON SPRING CALIPER FOR METAL AND PORCELAIN	126
IWANSON SPRING CALIPER FOR WAX	126

J	
JACUETTE SCALER	63
JARABAK PILERS	143
JECT ULTIMA DENTAL SYRINGES	27
JENNINGS RETRACTORS - MOUTH GAGS	100
JOHNSON CONTOURING PLIERS	133
JOHNSON PLIERS FOR CROWN BAND CONTOURING	138
JONES TOWEL CLAMPS	110
JOSEPH GUM SCISSORS	105

K	
KALT NEEDLE HOLDERS TC	109
KELLS EXTRACTING FORCEPS (AMERICAN PATTERN)	15

DESCRIPTION	PAGE#
KELLY GUM SCISSORS	104,105
KELLY HAEMOSTATIC FORCEPS	110
KELLY-RANKIN HAEMOSTATIC FORCEPS	110
KEY RINGS	94
KEYS FOR IMPLANT SCREW	177
KILNER (RAGNELL) GUM SCISSORS	105
KIRKLAND SCALER	64
KLEIN EXTRACTING FORCEPS	08
KLEINERT-KUTZ BONE ROUNDNER	25
KOPP ROOTS ELEVATOR	39
KRAMER NEVINS SINUS LIFT	162
KRAMER-NEVINS PERIODONTAL INSTRUMENTS	121
KRARNER-NEVINS BONE CHISEL	119
KUEHNE TWEEZERS	170
L	
LA GRANGE NEEDLE HOLDERS	109
LA GRANGE GUM SCISSORS	104,105
LADMORE FILLING INSTRUMENTS	88
LADMORE IMPLANTOLOGY	149
LAGRANGE SCISSORS	108
LAGRANGE SUPER CUT SCISSORS	108
LANGENBECK RETRACTORS	103
LANGER SCALER	63
LAP & L-KEY JOINT PLIERS	139
LARGE FLUCH-CUT DISTAL AND CUTTING PLIERS	133
LAXUTOR ROOT ELEVATORS	30,31
LAXUTOR ROOT ELEVATORS SET OF 9 PCS	38
LE CRON CEMENT SPATULAS	95
LECLUSE BAYONET ROOT ELEVATOR	41
LESSMANN WAX KNIVES	96
LICHTENBERG-RYDER T.C NEEDLE HOLDERS	109
LIGATURE FORMING PLIERS	134
LIGATURE INSTRUMENT SILICON GRIP	129
LIGHT WORE BIRD BEAK PLIERS WITH GROOVE	143
LINDO LEVIAN ROOT ELEVATORS	35
LINGUAL / PALATAL ARCH FORMING PLIERS	134
LINGUAL ARCH FORMING PLIERS	143
LINGUAL DENTAL PHOTOGRAPHIC MIRRORS	98
LINGUAL/PALATAL SURFACES SCALER	61
LINGUAL-LARGE DENTAL PHOTOGRAPHIC MIRRORS	98
LIP & CHEEK RETRACTOR	100
L-KEY JOINT PLIERS	139to138
LOCKLIN GUM SCISSORS	105
LONDON COLLEGE TWEEZERS	52
LONDON HOSPITAL	34
LONG IMPLANT DRILLS	176
LOOP FORMING IN FOUR LENGTH	138
LORNHAEMOSTATIC FORCEPS	110
LUCAS IMPLANTOLOGY	168
LUER BONE ROUNDNER	25
LUKS	58
LUXATING ELEVATOR / PERIOTOME	36
LUXATING ELEVATOR WITH PERIOTOME TIP	36
LUXATOR ROOT ELEVATORS	29
LUXATOR/ELEVATOR 8 PCS	191
LUXATORS SET OF 7 PCS	46
LUXATORS SET OF 7 PCS	46
LUXATORS SET OF 8 PCS	46
LUXIER ROOTS ELEVATOR	40
LUXIVATORS CURVED ATRAUMATIC LUXATION OF THE TOOTH	48
LUXIVATORS STRAIGHT ATRAUMATIC LUXATION OF THE TOOTH	48
M	
MAGNIFYING MOUTH MIRRORS	49
MALLET IMPLANTOLOGY	174
MALLETS - PLASTER SHEARS - SAWS & BLADES	124
MANUAL ASPIRATING SYRINGE	27
MANUAL CROWN REMOVERS	114
MARGIN TRIMMERS	86
MARGINAL RIDGE & EMBRASURE SHAPING INSTRUMENT	148
MARKLEY FILLING INSTRUMENTS	93
MARQUETTE CONDENSER	87
MARQUETTE PLUGGERS	87
MARYAM TWEEZERS	53
MATHIEU NEEDLE HOLDERS	107
MATRIX RETAINERS	115
MAXI HOLLOWARE INSTRUMENTS	187
MAYO GUM SCISSORS	104
MAYO NEEDLE HOLDERS	106
MAYO TRAY PERFORATED	183
MAYO-HEGAR NEEDLE HOLDERS	106,107
MCCALL SCALER	63
MEAD BONE ROUNDNER	25
MEAD NON AUTO CLAVABLE PLASTIC TIPS	119
MEASURING LOOP	126
MEASURING LOOP CASTROVIEJO	126
MEASURING PROBE	145
MEISSNER EXTRACTING FORCEPS	26
MEMBRANE IMPLANTOLOGY	161
MEMBRANE 3POSITIONING IMPLANTOLOGY	150
MEMBRANE DETACH ELEVATOR	164
MEMBRANE ELEVATOR	164
MEMBRANE TWEEZERS	170
MERIAM TWEEZERS	52
MERRIT 6 EXPLORERS	55
MERSHON BAND PUSHER	129
MESH CASSETTES 5 PIECES, 7 PIECES, 10 PIECES, 15PIECES & 20 PIECES	190
MESH TRAY	190
MESH TRAYS 05 PCS	190
MESH TRAYS 07 PCS	190
MESH TRAYS 10 PCS	190
MESH TRAYS	190
MESH TRAYS 20 PCS	190
MESIAL SCALER	61
METZENBAUM GUM SCISSORS	104,106
MICOR ADSON 1X2 TISSUE FORCEPS	169
MICRO BOLEY GAUGE STRAIGHT	146
MICRO BOLEY GAUGE TWISTED	146
MICRO IRIS GUM SCISSORS	104
MICRO SURGICAL SCALPEL HANDLE TITANIUM	123
MICRO-FRIEDMAN BONE ROUNDNER	25
MICRO-MINI PIN & LIGATURE CUTTER	142
MIDDELBOERFP RETRACTORS	103
MILLER BONE FILES	119
MILLER ROOT ELEVATORS	37

DESCRIPTION	PAGE#
MILLER IMPLANTOLOGY	168
MILLER ROOT PLANNING FILES	119
MILLER TWEEZERS	53
MINI DISTAL AMALGAM CARRIERS	117
MINI GAUGE	127
MINI LIGATURE CUTTERS	133
MINI PIN & LIGATURE CUTTER	142
MINI PIN & LIGATURE CUTTER TC	139
MINI-LANGENBECK RETRACTORS	102
MINI-SPATEL BURNISHERS	71
MINNESOTA RETRACTORS	101
MIRROR EXPLORERS	51
MIRROR HANDLE STEM WITH RULE HANDLES FOR MOUTH MIRRORS	50
MISCELLANEOUS PRODUCTS	94
MIXING SPATULA WITH SHOVEL	165
MOLT 9 PERIODONTAL INSTRUMENTS	121
MOLT AUTO CLAVABLE PLASTIC TIPS	119
MONARI COMPOSITE MODELLING INSTRUMENTS	85
MORTENSON FILLING INSTRUMENTS	80,87
MOUTH MIRROR EXPLORERS	51
MOUTH MIRRORS	49
MOUTH PROPS	94
MOVEABLE HEIGHT GAUGE	125
MSY CEMENT SPATULAS	95
MUHELMANN SCALER	64,85
MULTIFUNCTIONAL METER	145
MULTI-PURPOSE PLIERS	137
N	
NAKAWALNI DENTAL LABORATORY INSTRUMENT	97
NANCE LOOP FORMING PLIERS	132,137
NAPKIN HOLDER WITH METAL CHAIN	94
NAPKIN HOLDER WITH PLASTIC CHAIN	94
NARROW SIOVELAND RETAINERS	115
NEEDLE HOLDERS	106to109
NEEDLE STERILIZATION TUB	186
NEUMANN GUM SCISSORS	105
NEVINS EXTRACTING FORCEPS (AMERICAN PATTERN)	14,16
NORMAL HANDLE EXPLORERS	54
NOYES GUM SCISSORS	105
O	
OBTUSE IMPLANTOLOGY	161
OCCUSAL ANATOMY INSTRUMENT	148
OHL PERIOSTEEL ELEVATORS	120
OLSEN-HEGAR NEEDLE HOLDER WITH SCISSORS	107
OMEGA LOOP FORMING PLIERS	141
ORBAN SCALER	64
ORTHO BAND PUSHER SCALER	131
ORTHO INSTRUMENT	130
ORTHO LIGATURE DIRECTOR SINGLE ENDED	131
ORTHO LIGHT BAND PUSHER SCALER	129
ORTHO LIGHT DOUBLE ENDED LIGATURE	131
ORTHO LIGHT DOUBLE ENDED LIGATURE DIRECTOR	131
ORTHO LIGHT DOUBLE ENDED LIGATURE DIRECTOR SCALER	129,131
ORTHO LIGHT DOUBLE ENDED LIGATURE SCALER	131
ORTHO LIGHT LIGATURE DIRECTOR DOUBLE ENDED	131
ORTHO LIGHT SCALER	130
ORTHO LIGHT SCALER DOUBLE ENDED	130
ORTHO LIGHT SCALER HEAVY	130
ORTHO LIGHT SCALER SINGLE ENDED	131
ORTHO RULER / CONE SOCKET	146
ORTHODONTIC INSTRUMENTS	125to131
ORTHODONTICS PLIERS STANDS	144
ORTHOLITE LIGATURE DIRECTOR SCALER	131
OSTEOMETER MEASURING FORCEPS FOR JAW	146
OSTEOTOME CONVEXES / CONCAVE / CONIQUES	171,172
OSTEOTOME CONVEXES / CONCAVE / CONIQUES SET OF 5 PIECES	172
P	
P.K. THOMS WAXING INSTRUMENTS KIT	89
P.K. THOMS WAXING INSTRUMENTS SOLID HANDLE	89
PALATAL-ADULT DENTAL PHOTOGRAPHIC MIRRORS	98
PALATAL-ADULT LARGE DENTAL PHOTOGRAPHIC MIRRORS	98
PALATAL-CHILD DENTAL PHOTOGRAPHIC MIRRORS	98
PALMER RUBBER DAM CLAMPS FORCEPS	111
PARMLY EXTRACTING FORCEPS (AMERICAN PATTERN)	16
PARTSCH PERIOSTEEL ELEVATORS	120
PDL ELEVATORS	47,48
PDL ELEVATORS SET OF 7 PCS	47
PDL ELEVATORS SET OF 7 PCS	47
PDL ELEVATORS SET OF 8 PCS	48
PEDIATRIC TOOTH EXTRACTING FORCEPS SET	08
PEET SPLINTER FORCEPS	109
PERFORATED WITH RIM LOCK SET OF 06 PCS	179
PERFORATED WITH RIM LOCK SET OF 10 PCS	179
PERFORATED WITH RIM LOCK SET OF 8 PCS	179
PERIODONTAL CHISELS	118
PERIODONTAL INSTRUMENTS	120to122
PERIODONTAL KNIVES	64
PERIODONTAL PROBES	58
PERIODONTAL PROGRESSPREADERS	57
PERIODONTAL SURGERY	162
PERIOSTEEL	
ELEVATORS	120,154
PERIOTOME ROOTS ELEVATOR	43
PERRY TWEEZERS	52,53
PHYSIC EXTRACTING FORCEPS (AMERICAN PATTERN)	18
PIN & LIGATURE CUTTER	142
PIN & LIGATURE CUTTERS TC	139
PIN HOLDING PLIER TC	140
PIN-TWEEZERS	170
PLAIN MOUTH MIRRORS	49
PLANATOR	69
PLANATOR	69
PLASTER KNIFE	96
PLASTER SHEARS	124
PLASTIC FILLING INSTRUMENTS	93
PLIER STAND PLASTIC	144
PLIER STAND STAINLESS STEEL	144
PLIERS FOR ORTHODONTICS & PROSTHETICS	132to143
PLIERS STAND STAINLESS ROD (ALUMINUM ANODIZED)	144
PLUGGERS	56
PLUGGERS/CONDENSERS	87
POSITIONING 3 IMPLANTOLOGY	161

DESCRIPTION PAGE#

POSITIVE POSTIONER	125
POSTERIOR BAND REMOVING PLIERS - LONG	141
POSTERIOR BAND REMOVING PLIERS - SHORT	141
POTTS 'T-HANDLE' ELEVATOR-LEFT	41
POTTS 'T-HANDLE' ELEVATOR-RIGHT	41
PRICHARD PERIODONTAL INSTRUMENTS	121
PROBE EXPLORERS	51
PRONG 3 CLASP ADJUSTABLE PLIER TC	140
Q	
QUATRO DENTAL SYRINGES	27
R	
RASPATOR, PRICHARD	165
RASPATOR, RASPATORY	120
RASPATOR, WILLIGER	120
RECTANGULAR ARCH BENDING PLIERS	143
RETRACTOR SELDIN	103
RETRACTORS - MOUTH GAGS	99,100
RETRACTORS	101to103
RHODIUM MOUTH MIRRORS	49
RIBBON RETRACTORS	101
RIDGE MAPPING DOUBLE CALIPER	146
RING 2 DENTAL SYRINGES	27
ROCHESTER-KOCHER HAEMOSTATIC FORCEPCS	110
ROCHESTER-PEAN HAEMOSTATIC FORCEPCS	110
ROOT CANAL PLUGGER	29
ROOT ELEVATOR	29to48
ROOT ELEVATORS SET OF 10 PCS	46
ROOT FRAGMENT FORCEPCS	09,11
ROOT PICK ELEVATOR WITH GOLD FLEXIBLE POINTS	42
ROOT PLANNING FILES	119
ROOT PLANNING FILES & BONE FILES	119
ROOTS SPLINTER FORCEPCS	10
ROSER-KÖNIG RETRACTORS - MOUTH GAGS	100
ROUND AND CONCAVE PLIER	139
ROUND ENDODONTIC BOXES	186
ROUND EXCAVATOR	86
ROUND TORQUE WRENCH UNIVERSAL	177
ROUTURIER EXTRACTING FORCEPCS (ENGLISH PATTERN)	03
ROUTURIER EXTRACTING FORCEPCS FOR LOWER MOLARS	03
RUBBER DAM CLAMPS	113
RUBBER DAM CLAMPS FORCEPCS	111
RUBBER DAM CLAMPS KITS	112
RUBBER DAM FRAME	111
RUBBER DUM TEMPLATE	112
RULER	127
RULER WEDGE	127
RUSSIAN LONG TISSUE FORCEPCS	170
RUSSIAN TISSUE FORCEPCS	170
RYDER NEEDLE HOLDERS	106,107
S	
SAW BLADES	124
SCALER	59to67
SCALERS TRAYS	183
SCALPEL HANDLE STRAIGHT	123
SCALPEL HANDLES	123
SCHLEMMER ROOTS ELEVATOR	37
SCHMIDLIN PERIODONTAL INSTRUMENTS	122
SCHURE BAND SEATER	130
SCHWÄRZ PLIERS	139
SEPARATING ELASTIC PLIER	111
SELDIN PERIODONTAL INSTRUMENTS	122
SELDIN ROOT ELEVATORS	29,32
SELF LOCKING GROOVED	169
SELF-LOCKING TWEEZER	53
SEMKEN TAYLOR TWEEZERS	52
SENN MUELLER RETRACTOR	102
SERRATED PLUGGERS	84
SET OF 5 PIECES	171
SHEPHERD'S HOOK EXPLORER	54
SHORT IMPLANT DRILLS	176
SICKLE SCALERS	63
SIMPLEX RETRACTOR	100
SINUS ELEVATOR & MEMBRANE LIFT TIPS	164
SINUS IMPLANTOLOGY	156,161
SINUS LEFT ELEVATOR & MEMBRANE LIFT TIPS 3 SET OF 7 PCS	164
SINUS LEFT ELEVATOR SET OF 10 PCS	158
SINUS LIFT ELEVATOR	151,157
SINUS LIFT ELEVATORS SET OF 7 PCS WITH CASSETTE	157
SINUS LIFT INSTRUMENT	150to152,161
SINUSLIFT IMPLANTOLOGY	150,161
SIQVELAND RETAINERS	115
SLIM WEINGART PLIERS	141
SLIPPER TWEEZERS	128
SMAHA ELASTOMERIC LIGATURE PLACING FORCEPCS	140
SMALL/MEDIUM BALL BURNISHER	149
SOFT BRUSHING KIT SET OF 6 PCS	163
SOFT WIRE AND LIGATURE CUTTER	135
SOFT WIRE AND LIGATURE CUTTER, STANDARD	135
SPATULAS	73
SPATULAS ROUNDED AND SHARP	72
SPECIAL INOX	124
SPECIAL INOX WAX KNIVES	96
SPENCER GUM SCISSORS	105
SPIRIT LAMP	186
SPLINTER FORCEPCS	10
SPOON AND PUSHER (TRINOVO)	167
STANDARD LIGATURE CUTTER TC	139
STAR TORQUE WRENCH UNIVERSAL	177
STERILIZING BOXES & INSTRUMENTS TRAYS	184
STERILIZING MESH TRAY	190
STERNBERG RETRACTORS	99
STIEGLITZ ROOT FRAGMENTS	10
STIEGLITZ SPLINTER FORCEPCS	10
STOCKES RUBBER DAM CLAMPS FORCEPCS	111
STOP PLIERS V-BEED	137
STRAIGHT DIRECT BOND BRACKET REMOVER TC	140
STRIP SAW	125
SUCTION CANNULA KIT WITH 3 NEEDLES	178
SUCTION NEEDLE	178
SUCTION PIPE	178
SUCTION TUBES	178
SURGICAL TWEEZERS	52

DESCRIPTION PAGE#

SURGICAL BALL HOOK CRIMPING PLIERS, ANGLED	137
SURGICAL BALL HOOK CRIMPING PLIERS, STRAIGHT	137
SURGICAL CHISELS	162
SUTURE PLIERS SUTURE FORCEPCS	169
SWEDISH TYPE DENTAL SYRINGES	27
SYNDEMOTOMES ROOTS ELEVATOR	43
T	
TAMPER	166
TANNER FILLING INSTRUMENTS	88
TARTAR REMOVER INSTRUMENTS SOLID HANDLE	67
TAYLOR SCALER	63
THICK EXPLORERS	54
THREE JAW PLIERS	143
TISSUE GRAFT FORCEPC SERRATED TEETH	169
TISSUE MEMBRANE FORCEPCS	169,170
TISSUE PUNCH	173
TISSUE PUNCH FORCEPCS TO REMOVE TISSUE AFTER USING PUNCH	170
TISSUE PUNCH SET OF FIVE PIECES	173
TISSUE PUNCH STRAIGHT & CURVED	173
TISSUE PUNCH WITH PIN SET OF FOUR PIECES	173
TITANIUM LOCKING PLIER	169
TITANIUM PERIOSTEAL ELEVATOR FOR IMPLAN	122
TOFFLEMIRE-JUNIER SIQVELAND RETAINERS	115
TOFFLEMIRE-SENIOR SIQVELAND RETAINERS	115
TOMAS EXTRACTING FORCEPCS (AMERICAN PATTERN)	17,22
TOMNIS NEEDLE HOLDERS	109
TORQUE WRENCH & RATCHET	177
TORQUING PLIERS SET	137
TOWNER-JAQUETTE SCALER	63
TREPHINE	175
TREPHINE DRILL SET OF EIGHT PIECES	175
TRINOVO HANDLE	167
TRIO DENTAL SYRINGES	27
TRIPLE-ANGLED BACK ACTION EXCAVATOR	86
TWEED / ANGEL FORMING AND TORQUING PLIERS	134
TWEED / ANGEL RECTANGULAR ARCH FORMING AND TORQUING PLIERS	137
TWEED / ANGLE RECTANGULAR ARCH FORMING & TORQUING PLIERS	133
TWEED LOOP FORMING PLIERS	132,133,143
TWEEZERS	52,53
TWEEZERS EXPLORERS	51
TWEL-ON ELASTIC MODULE INSTRUMENT	130
TYPE C DENTAL SYRINGES	27
U	
UNIQUE RETRACTORS	102
UNIVERSAL CROWN REMOVER	114
UNIVERSAL CURETTES	63
UNIVERSAL CUT & HOLD DISTAL END CUTTER	142
UNIVERSAL DOLPHIN STYLE WIRE BENDING & CUTTING PLIERS	132
UNIVERSAL EXTRACTING FORCEPCS (AMERICAN PATTERN)	22
UNIVERSAL MINI-ELEVATOR FOR FRAGMENTS	34
UNIVERSAL NEEDLE HOLDERS	106
UNIVERSITY OF MICHIGAN EXPLORERS	55
UNIVERSITY OF NORTH CAROLINA EXPLORER	55
UPPER ROOT ELEVATOR WITH HELICOIDAL TIP	31
US ARMY RETRACTORS	102
UTILITY PLIER WEINGART TC	140
V	
V BEND STOP	139
V BEND STOP PLIER TC	139
VERNIER GAUGE	127
VISTA TUNNELING INSTRUMENTS SET	155
W	
W BARRY ROOTS ELEVATOR	41
WAHL BONE FILES	119
WAKAI HEAT CARRIERS	57
WALDSAVHS WIRE BENDING AND CUTTING PLIERS	134
WANGEN HOLDER	99
WARD FILLING INSTRUMENTS	80
WATER SYRINGE	116
WAX KNIVES	96
WAY 6 ADJUSTABLE ANGLED SCALPEL HANDLE	123
WEIDER RETRACTOR	99
WEINGART PLIER	139
WEINGART PLIER MEDIUM	132,134
WEINGART PLIERS	141
WEINGART UTILITY PLIERS	136
WEINGART-MINI UTILITY PLIERS	136
WEITLANER RETRACTORS - MOUTH GAGS	100
WERDELSTÄDT SCALER	67
WESTCOTT BURNISHERS	68
WESTCOTT FILLING INSTRUMENTS	93
WESTON CEMENT SPATULAS	95
WHITE BURNISHERS	68
WIDE SIQVELAND RETAINERS	115
WILAND SCALER	65
WILKINS/TUFTS EXPLORER	54
WILLIAMS EXPLORERS	55
WILLIAMS FILLING INSTRUMENTS	81
WINTER EXTRACTING FORCEPCS (AMERICAN PATTERN)	12
WINTER ROOTS ELEVATOR	41
WIRE BENDING & LOOP FORMING PLIERS	132
WIRE BENDING AND LOOP FORMING PLIERS ANGLED (BIRD BEAK)	136
WISDOM EXTRACTING FORCEPCS	03
WISDOM ROOT ELEVATOR	36
WITZEL FORCEPCS WITH ANATOMICAL HANDLE SET OF 3 PCS	09
WITZEL FORCEPCS WITH GOLD SET OF 3 PCS	09
WITZEL FORCEPCS WITH HOLE AND SCREW PATTERN SET OF 3 PCS	09
WITZEL ROOT FRAGMENT FORCEPCS	09
WOODEN HANDLE WAX KNIVES	96
X	
X RAY FILM HANGERS	94
Y	
YOUNG TONGUE FORCEPCS	110
YOUNG WIRE BENDING & LOOP FORMING PLIERS	132
YOUNGER GOOD SCALER	63
Z	
ZAHLE CEMENT SPATULAS	95



MEDSTR INTERNATIONAL

Manufacturers, & Exporters of Dental, Surgical, Orthodontic, Hollow Wears & Manicure Instruments.

Small Industrial Estate Tipu Road, Sialkot - Pakistan

Phone: +92 3076343454

Email: faraz@medstrintl.com

Web: www.medstrintl.com

